

# JMAJ

## Japan Medical Association Journal

### CONTENTS

#### *Sexually Transmitted Diseases*

- Recent Trends in *Neisseria gonorrhoeae* Infection  
Shoichi ONODERA ..... 499
- Sexually Transmitted Infections and Sterility  
Masayoshi NOGUCHI and Yasuyuki NOGUCHI ..... 506
- Genital Herpes  
Michihito NIIMURA ..... 511
- Current Status of *Trichomonas vaginalis* Infection,  
a Sexually Transmitted Disease  
Nobuo KAWAMURA ..... 516
- Sexual Practices and the Risk for HIV/STDs Infection of Youth in Japan  
Masako ONO-KIHARA *et al.* ..... 520

#### *Hepatitis C*

- Extrahepatic Manifestation in Hepatitis C  
Hidetsugu SAITO ..... 526

#### *Child Development*

- When a Child Shows Signs of Retardation in Development  
—When a question arises about a child's development—  
Shunsuke NUMAGUCHI ..... 532

#### *Psychiatric Disorder*

- Neuroimaging for Diagnosis of Psychiatric Disorders  
Yoshio HIRAYASU ..... 538

---

Table of Contents of Japan Medical Association Journal Vol. 45, Nos. 1–12, 2002 .....	545
--	-----

---

# Recent Trends in *Neisseria gonorrhoeae* Infection

JMAJ 45(12): 499–505, 2002

Shoichi ONODERA

*Professor, Department of Urology, The Jikei University School of Medicine*

**Abstract:** Recent epidemiological trends in *Neisseria gonorrhoeae* (NG) infection and the appearance of drug-resistant strains of this bacterium in Japan are reported. In Japan, the number of patients with *N. gonorrhoeae* infection began to rise again around 1995, and has been increasing since. This increase, as well as the increase in number of patients with genital *Chlamydia trachomatis* infection and HIV infection, has attracted close social scrutiny. Epidemiologically, the following factors have been pointed out as being responsible for these trends: (1) diversification of patterns of sexual behavior, (2) lower ages at which children have begun to exhibit sexual behavior, and (3) increase in the prevalence of asymptomatic gonococcal infection. In recent years, the percentage of high school students who have experienced sex has been increasing sharply in Japan, and the number of young patients (younger than 20 years of age) with sexually transmitted diseases has shown a marked increase. It has also come to attention that condoms are often not used properly. It is epidemiologically significant that in more than half of all males with gonococcal urethritis, the disease is transmitted during oral sex with commercial sex workers (CSWs). From the standpoint of bacteriology, it is noteworthy that about half of all the *N. gonorrhoeae* strains isolated in Japan are quinolone-resistant *N. gonorrhoeae* (QRNG). Over the past two years or three, *N. gonorrhoeae* strains resistant to third-generation cepheims have also been detected. Such drug-resistant NG strains pose a serious threat to the community. They differ from previously known drug-resistant NG strains in that they exhibit resistance to quinolones and cepheims while not producing  $\beta$ -lactamase. It is thus a matter of priority to clarify the mechanism of development of resistance of these strains. Education for the prevention of sexually transmitted diseases, not just gonococcal infection, and efforts to promote appropriate therapy for this category of infections are urgent needs of the day.

**Key words:** Gonococcal infection; Epidemiological trend;  
Drug-resistant *Neisseria gonorrhoeae*

---

This article is a revised English version of a paper originally published in the Journal of the Japan Medical Association (Vol. 126, No. 9, 2001, pages 1123–1127).

## Introduction

In the past, *Neisseria gonorrhoeae* (NG) infection was considered to be one of the four major sexually transmitted diseases (STDs). At present, it is categorized as one of the class IV infectious diseases under the new Infectious Diseases Law. The epidemiological trends of gonococcal infection become apparent when we analyze the reports filed pursuant to the old Venereal Disease Prevention Law, and the data collected under the current fixed spot survey program of the Japanese Ministry of Health, Labor and Welfare (MHLW).

In 1950, two years after the Venereal Disease Prevention Law was promulgated, about 180,000 cases of gonococcal infection were reported.

The reported incidence of this infection decreased sharply soon after, reaching about 4,600 in the first half of the 1960's. It is evident that the public health measures taken after the end of World War II contributed markedly to this reduction in the number of patients with the infection. The decrease may also be attributable to the following factors: (1) Patients with gonorrhoea, especially males, often have symptoms that become manifest soon after the infection, making it easy to identify the source of infection; and (2) antibiotics, such as penicillins exerted excellent effects on this bacterium at that time.

However, the prevalence of gonococcal infection did not continue to decrease, and started to show repeated cycles of increase and decrease. Now, the incidence of the disease has been increasing since 1995. This latest tendency has been attributed to factors such as the diversification of sexual behavioral patterns, lower age at which children have begun to exhibit sexual behavior, liberalization of views on sex, and an increase in the prevalence of asymptomatic gonococcal infection. On the other hand, a factor related to the pathogenic bacterium, i.e., continual acquisition of drug resistance by the bacterium, is also viewed as an important factor associated with the recent increase in the

prevalence of gonococcal infection.

The distribution of drug-resistant NG varies greatly among different districts of the world, but Japan is certainly one of the countries with the highest percentage of drug-resistant NG. It is therefore important that clinicians in this country review their practices in regard to the treatment of this infection with antimicrobial agents.

With this background, in this paper, we shall discuss the characteristics and problems associated with the treatment of gonococcal infection in Japan.

## Recent Epidemiological Trends in Gonococcal Infection

The Japanese Ministry of Health and Welfare (now reorganized as the Ministry of Health, Labor and Welfare) began to conduct fixed-point surveys of sexually transmitted diseases (STDs) at selected medical facilities in various districts of Japan in 1987. Figure 1 shows the number of males and females with gonococcal infection or genital *Chlamydia trachomatis* infection reported after 1991. The number of cases with gonococcal infection decreased markedly from 1992 to around 1994. This decrease is considered attributable to the widespread increase in the awareness among people of the necessity to avoid dangerous sexual behavior following the report of the death of a female commercial sex worker due to AIDS in Kobe in 1987, and the World AIDS Day (December 1) campaign which began in 1991. However, since the actual increase in the number of patients with AIDS, which is transmitted by the sexual route, was smaller than expected, the fear among the general public of acquiring STD also began to wane. This probably led to the resurgence in the number of patients reported with STD after 1995. This tendency towards increasing incidence has been continuing to date.

Kumamoto *et al.* criticized the MHLW's fixed-spot survey program, arguing that the selection of the fixed-survey spots was biased towards

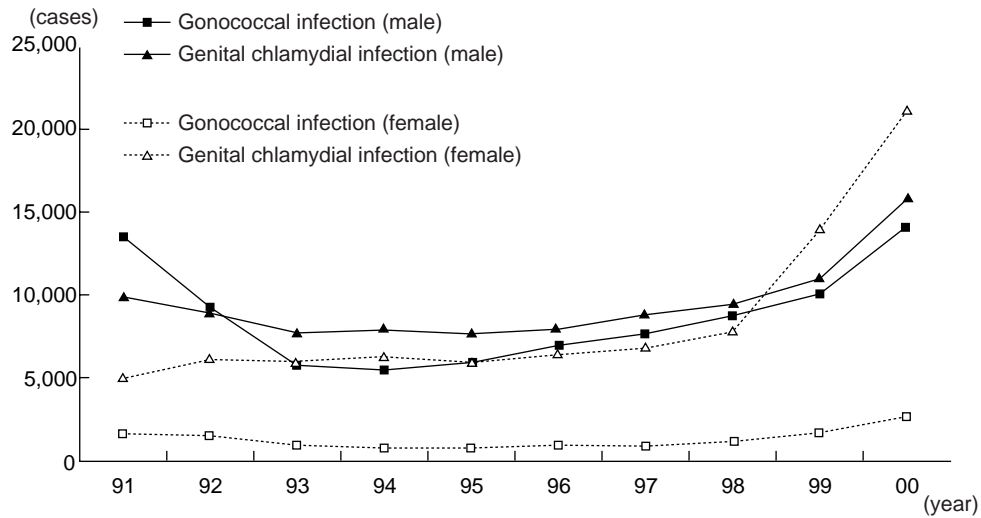

Fig. 1 Reported cases of sexually transmitted diseases (males and females)

urological facilities, and that the number of females reported from obstetric and gynecological facilities was small, which failed to highlight the current tendency of transmission of STD in which women play a central role.<sup>1)</sup> However, as shown in Fig. 1, the number of female patients reported with genital chlamydial infection has increased sharply since 1999, and the overall trends revealed by the fixed-spot surveys now are similar to those reported by Kumamoto *et al.*<sup>1)</sup> This is probably attributable to the increase in number of reports from front-line clinicians following designation of their facilities as fixed-survey spots under the new act. The surveillance conducted by the MHLW now seems to reflect the actual state with considerably high reliability. In any event, a definite new wave of increase in the prevalence of gonococcal infection has become evident over the past two or three years. Several problems that could be responsible for this tendency have been pointed out.

First, probably reflective of the recent downward trend of the economic status in Japan, it has become cheap for people to satisfy their sexual appetites, which has led to an increase in the incidence of infection transmitted by oral sex with commercial sex workers. According to our

survey conducted in 1999 to determine the sources of infection of gonococcal urethritis in metropolitan areas (Tokyo and surrounding prefectures), gonococcal urethritis was transmitted by oral sex in about a half of all the cases.<sup>2)</sup> Neither patients, nor carriers of NG infection are aware that NG can be transmitted by this route. Furthermore, most of the oral carriers of NG are almost, if not entirely, symptom-free. It has been reported previously that individuals carrying NG in their oral cavity or rectum have almost no subjective symptoms. Furthermore, the percentage of cases without severe symptoms among males with gonococcal urethritis has also been increasing.

The incubation period from infection to the onset of this disease was previously considered to be 1–5 days. In our recent survey, however, this period was a little longer, about 7.4 days on an average.<sup>2)</sup> In this connection, Kojima *et al.* reported that the incubation period for pharyngeal NG disease tended to be longer than that for disease transmitted via the genital route.<sup>3)</sup>

Another important observation is the tendency towards increase in the number of younger patients presenting with gonococcal infection. As shown in Fig. 2, according to the 1999–2000 statistics, the percentage of patients

younger than 20 years of age, especially females, among all patients with gonococcal infection has increased markedly; 20% of all the patients reported during this period were younger than 20 years old. Regarding the sexual trends among younger people, it has been reported that the percentage of high school students who have experienced sex has rapidly increased over the past few years, touching 37.8% for males in the third year of senior high school, and 39.0% for females of the same age.<sup>4)</sup> It has also been pointed out that students who have more sexual partners tend to use condoms less frequently, and that condoms are often not used during oral sex.<sup>5)</sup> Thus, it will be particularly important, for controlling the spread of gonococcal infection, to educate young people regarding sexual practices and STDs.

### Problems Associated with the Treatment of NG Infection

In the past, penicillins exerted excellent antibacterial activity against NG. However, a number of drug-resistant NG strains, beginning with penicillinase-producing NG (PPNG), have been increasingly isolated. In recent years, quinolone-resistant NG has been a focus of attention in Japan and some Southeast Asian countries. Norfloxacin was marketed in 1984 in Japan as the first new fluoroquinolone. At that time, this drug exerted reasonably high antibacterial activity against NG. Since the frequency of isolation of PPNG had also begun to increase sharply in those days, the use of fluoroquinolones for the treatment of gonococcal disease inevitably increased. Subsequently marketed fluoroquinolones, such as ofloxacin and tosufloxacin, were not only effective against NG but also against *Chlamydia trachomatis* (CT). For this reason, the fluoroquinolones began to be used as the drugs of first choice for the treatment of sexually transmitted urethritis.

In Western countries, as a rule, gonococcal infection is treated with a single oral dose or injection of the drug. In Japan, on the other

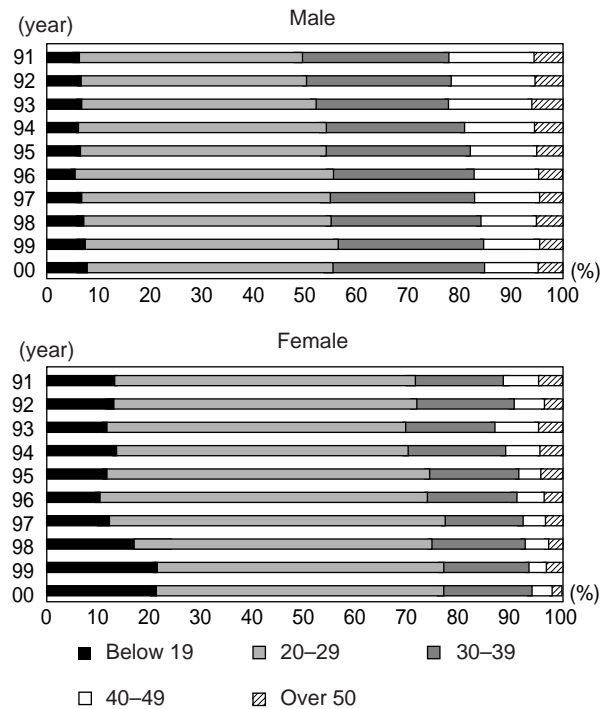

Fig. 2 Reported cases of *Neisseria gonorrhoeae* infection analyzed by sex and age

hand, it was recommended that drugs that can eradicate both NG and CT infection be used in the treatment of gonococcal infection. As a result, one- to two-week courses of treatment with the fluoroquinolones were frequently used for the treatment of gonococcal urethritis and urethritis caused by CT.

The recent sharp increase in the frequency of isolation of QRNG strains in Japan and other Southeast Asian countries, despite the rather low frequency of their isolation in Western countries, is considered to be perhaps associated with the differences in the methods used for the treatment of gonococcal infection between Japan and some Southeast Asian countries, and Western countries. In other words, we may say that the prolonged courses of treatment with the fluoroquinolones may have precipitated the development of new drug-resistant NG strains. Until a few years ago, the new oral cepheps exerted excellent activity against these QRNG strains. Over the past year or two, however, the

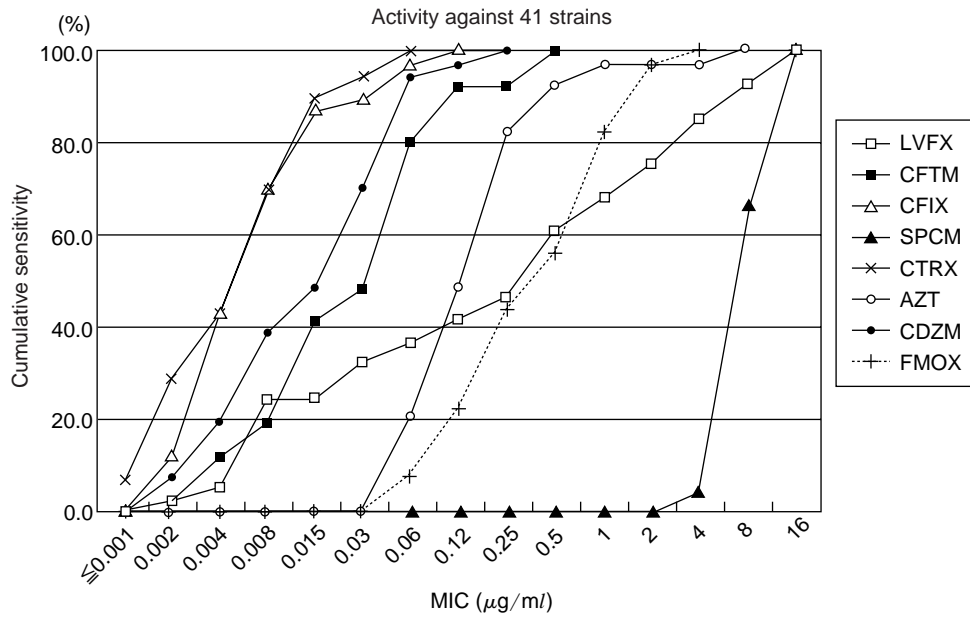

Fig. 3 Sensitivity of *Neisseria gonorrhoeae* isolated in 1999

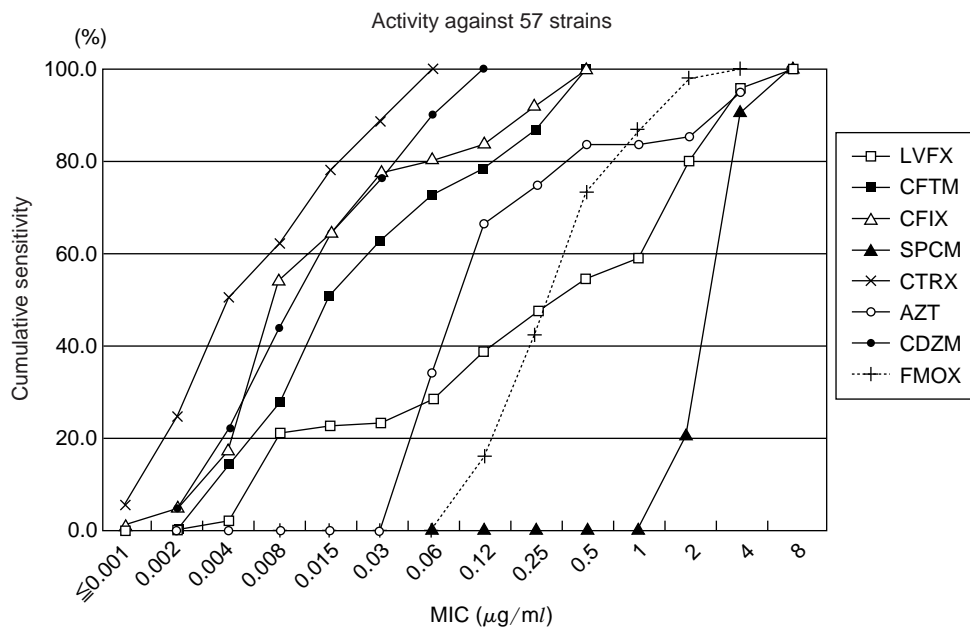

Fig. 4 Sensitivity of *Neisseria gonorrhoeae* isolated in 2000

frequency of isolation of NG strains resistant to 3rd and 4th generation oral cepems has been increasing. Thus, the appearance of non-β-lactamase producing NG strains resistant to fluoroquinolones and cepems has begun to

attract close attention clinically. We analyzed the activity of various antibacterial agents against NG strains isolated from patients with gonococcal urethritis in metropolitan areas in 1999 and 2000 (Figs. 3 and 4).<sup>6)</sup>

The MIC of levofloxacin (LVFX) and spectinomycin (SPCM) against NG has remained unchanged. The MIC of two injectable cepheims, i.e., ceftriaxone (CTRX) and cefodizime (CDZM), have also not changed recently. However, resistant strains to cefixime (CFIX) and ceftamandole (CFTM) have been observed. The MIC<sub>90</sub> of CFIX and CFTM rose markedly from  $\leq 0.025$  and  $0.1 \mu\text{g}/\text{ml}$  to  $0.25$  and  $0.5 \mu\text{g}/\text{ml}$ , respectively. A tendency towards resistance to the injectable cepheims, aztreonam (AZT) and flomoxef (FMOX) was also observed. Interestingly, only one of the 98 NG strains isolated was PPNG, and none of the other strains produced  $\beta$ -lactamase.

Following the increase in the number of cephem-resistant NG strains over the past year or two in Japan, the Japanese Society of Sexually Transmitted Diseases made minor changes in the section pertaining to the treatment of gonococcal infection in the Guidelines for the Diagnosis and Treatment of Sexually Transmitted Diseases (1999) in 2001.<sup>7)</sup> Regimens of drug therapy recommended in the guidelines are presented below:

[Gonococcal urethritis]

- Spectinomycin:  
A single intramuscular dose (2.0 g)
- Cefodizime:  
A single intravenous dose (1.0 g)
- Cefixime:  
Two oral doses per day (200 mg/dose, for 3 days)

These regimens are also valid for gonococcal epididymitis and gonococcal cervicitis. However, spectinomycin is not indicated for gonococcal pharyngitis. The guidelines also comment that since NG strains have the potential to develop resistance, it may be difficult to completely eradicate NG with a single drug regimen. This highlights the necessity of paying adequate attention to the possibility of development of resistance by NG, and reviewing the validity of the currently used therapy.

## Conclusion

Recent epidemiological trends in gonococcal infection and problems related to its treatment known at present have been discussed in this paper. The prevalence of gonococcal infection has been increasing, associated with factors such as the increase in the incidence of infection mediated by oral sex, lower age of the patients, and a tendency towards increase in the number of patients with only mild or no symptoms.

Regarding the treatment of gonococcal infection, the frequency of isolation of NG strains resistant to fluoroquinolones or the newer cepheims has been increasing, indicating the necessity for drastically reviewing the conventional methods employed for the treatment of gonococcal infection in Japan. Adequate education on STD and promotion of the use of appropriate therapy are indicated.

## REFERENCES

- 1) Kumamoto, Y. *et al.*: Survey of sexually transmitted disease (STD) in Japan: Report of the STD sentinel surveillance for 2000. *Nihon Seikansensho Gakkaishi (Japanese Journal of Sexually Transmitted Diseases)* 2001; 12: 32–67. (in Japanese)
- 2) Endo, K., Madarame, J., Onodera, S. *et al.*: Current trend of gonococcal urethritis in the metropolitan area. *Nihon Seikansensho Gakkaishi (Japanese Journal of Sexually Transmitted Diseases)* 2000; 11: 126–131. (in Japanese)
- 3) Kojima, K.: Present status of STD. *Text for the Japan Urological Society Postgraduate Career Development Program for 1998* 1998; 3(1): 55–64. (in Japanese)
- 4) Tanomura, Y.: STD and sex education. *Sexually Transmitted Disease/HIV Infection: Its Present Status, Checks, Diagnosis and Treatment* (edited by the Sei No Kenko Igaku Zaidan), Medicalview, Tokyo, 2001; pp.66–69. (in Japanese)
- 5) Kihara, M.: STD and sexual behavior. *Sexually Transmitted Disease/HIV Infection: Its Present Status, Checks, Diagnosis and Treatment* (edited by the Sei No Kenko Igaku Zaidan), Medicalview, Tokyo, 2001; pp.70–73. (in Japanese)

- 6) Suzuki, H., Onodera, S., Kishimoto, K. *et al.*: Efficacy of ceftoram pivoxil in gonococcal urethritis. *Nihon Seikansensho Gakkaishi (Japanese Journal of Sexually Transmitted Diseases)* 2001; 12: 148–154. (in Japanese)
- 7) Japanese Society of Sexually Transmitted Diseases: Gonococcal Infection. *In: Guidelines for the Diagnosis and Treatment of Sexually Transmitted Diseases (2001 edition). Nihon Seikansensho Gakkaishi (Japanese Journal of Sexually Transmitted Diseases)* 2001; 12: 26–30. (in Japanese)



# Sexually Transmitted Infections and Sterility

JMAJ 45(12): 506–510, 2002

Masayoshi NOGUCHI\* and Yasuyuki NOGUCHI\*\*

*Professor\* and Assistant\*\*,*

*Department of Obstetrics and Gynecology, Aichi Medical University*

**Abstract:** The new Infectious Disease Prevention Law lists the following 5 diseases as those transmitted through sexual acts: syphilis, gonorrhea, Chlamydia infection of reproductive organs, herpes genitalis, and condyloma acuminatum. Among these, Chlamydia infection of reproductive organs and gonorrhea are likely to affect a woman's reproductive capacity. The former in particular, which far surpasses the latter in number of incidences, very frequently occurs in young women between 16 and 25 years of age. Therefore a concerted effort must be made to protect those women who may wish to reproduce in the future from Chlamydia infection that will lead to tubal sterility. Gyneco-obstetricians must note the physiopathology of tubal stenosis, tubal obstruction and adhesion around the Fallopian tubes that may be caused by a Chlamydia trachomatis infection and be familiar with the prophylaxis of this infection.

**Key words:** Chlamydia trachomatis infection; Tubal infertility; Sexually transmitted infection

## Introduction

Because of the recent liberal attitude toward sexual mores and advances in technology to identify the causative organisms, the reported incidence of sexually transmitted diseases has been increasing annually. It has been said that the number of diseases that can be transmitted to a sexual partner via a sexual act far exceeds 50.

The infections that are listed in the new Infectious Disease Prevention Law and that belong to the gyneco-obstetrical field include syphilis, gonorrhea, Chlamydia infection of

reproductive organs, herpes genitalis, and condyloma acuminatum.<sup>1)</sup>

Among these, gonorrhea and Chlamydia infection involving the reproductive organs may be singled out as those likely to affect fertility, thus blocking one's capacity to reproduce (Table 1). These two resemble to each other in that they cause changes to take place in the Fallopian tubes and the surrounding tissues, eventually leading to sterility. Due to the limited space allowed here, emphasis will be placed on the physiopathology and management of sterility caused by Chlamydia infection of the sexual organs, which occurs far more

This article is a revised English version of a paper originally published in the Journal of the Japan Medical Association (Vol. 126, No. 9, 2001, pages 1145–1148).

Table 1 Complications and Sequelae of STDs

	Infection of the fetus and infant	Abortion or premature delivery	Sterility	Diagnosis
Herpes genitalis	Birth canal infection Systemic herpes (very severe)	No (?)	No	Easy
Condyloma acuminata	Birth canal infection Oral papilloma	No	No	Easy at the external genitalia and its periphery; difficult in the uterus or cervix
Syphilis	Horizontal infection through the placenta	Yes	No	Diagnosis is easy with serological tests but the disease is often overlooked in spite of obvious syphilitic skin manifestation
Gonorrhea	Birth canal infection Neonatal pneumonia Conjunctivitis and neonatal blennorrhoea (leads to blindness)	Yes	Yes	Accurate diagnosis is possible with PCR but symptoms are scarce and diagnosis is otherwise difficult
Genital Chlamydia infection	Birth canal infection Conjunctivitis Neonatal pneumonia	Yes	Yes	Accurate diagnosis is possible with PCR but diagnosis is otherwise difficult due to scarcity of symptoms

Table 2 Outbreaks of Genital Chlamydia Infections (1999)<sup>3)</sup>

* Estimated number of patients among Japanese: 1,005,139 (862,724 women and 142,415 men)	
* Occurrence among women (per 100,000, rate per year)	
15 to 19 years	
Number with disease	850.4
Latent cases with no symptoms—others	3,401.5
Estimated number of patients	4,252 (4.3%)
	1/23.5 individuals
20 to 24 years	
Number with disease	1,342.5
Latent cases with no symptoms—others	5,370
Estimated number of patients	6,712.5 (6.7%)
	1/15 individuals

(partly changed)

often than gonorrhoea.

### The Current Status of Chlamydia Trachomatis Infection

When the trend in the incidence of sexually transmitted diseases (STD) in Japan, which was calculated using a specific point for a statistical basis, STD incidence surveys have con-

tinually shown that Chlamydia trachomatis infections occur more frequently among men. However, this approach — which was based on a specific point that is set in reference to urology — has been criticized for not presenting an accurate picture of the disease. In response to this criticism, a special committee was organized in 1998 by the Ministry of Health and Welfare (current Ministry of Health, Labor

and Welfare) to conduct a “Sentinel Surveillance on STD in a Model Prefecture.” Since then (i.e., 3 years), this committee has conducted data analyses, which are still ongoing.<sup>2)</sup>

According to this survey, Chlamydia trachomatis infection affects women about 6.0 times more frequently than men. More disturbing is that almost all cases are juveniles and young women between 15 to 19 and 20 to 24. Thus the previous data concerning the pattern of occurrence that were based on a specific point were radically altered.<sup>3)</sup> (Table 2)

As described later, the patients experience few subjective symptoms at the initial infection; and the condition is often left untreated until the disease spreads to the peritoneal cavity. Moreover, as the condition advances, it causes sterility, and an increase in the population segment that is incapable of reproduction. Such a trend must be stemmed as soon as possible.

### Symptoms of Chlamydia Infection

At the initial infection, the patient experiences few symptoms, the only possible initial symptom being an increase in leukorrhea due to cervicitis. However, this is often overlooked and the condition remains untreated. Chlamydia organisms that have proliferated in the cervix ascend from the uterus to the Fallopian tubes and invade the peritoneal cavity, while proliferating in the cells of the superficial layer of the oviducts. Having proliferated on the peritoneal surface, the organisms advance to the upper abdominal section. At the perihepatic region in particular, acute bacterial proliferation causes prominent upper abdominal pain (often resulting in acute abdomen) and the patient is brought to a hospital emergency service. It has been found that most cases of the violent upper abdominal pain affecting young women are caused by inflammation of the peri-hepatic region, in turn caused by a Chlamydia trachomatis infection (Fitz-Hugh-Curtis syndrome). Thus Chlamydia trach-

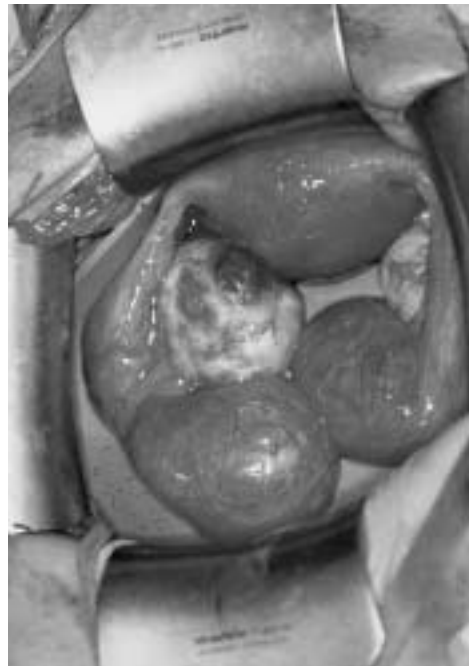

Fig. 1 Bilateral hydrosalpinx following Chlamydia trachomatis infection

omatis infection can evolve through a complex process, starting with the asymptomatic initial infection and culminating in a fulminant state.<sup>4,5)</sup>

### Physiopathology of Sterility Caused by Chlamydia Trachomatis Infection

#### 1. Adhesion of the fimbriae of the Fallopian tube and the development of hydrosalpinx

In an experimental infection, a rabbit that was inoculated with Chlamydia at the uterine cervix developed massive ascites on the 7th day. As seen in clinical patients who react positively in the nucleic acid amplification test for Chlamydia trachomatis and develop ascitic fluid accumulation in organs such as the Douglas pouch, these ascites coalesce and cause adhesion, forming hydrosalpinx. There has been a report on a case in which Chlamydia trachomatis infection had been confirmed and Chlamydia trachomatis DNA was successfully amplified in the fluid retained in bilateral

Table 3 Chlamydia Trachomatis Infection in Gyneco-obstetrics

Primary lesions	Secondary lesions
1) uterine cervicitis, endometriosis	1) adhesion around the uterine tube
2) adnexitis	2) stenosis of the uterine tube
3) pelviperitonitis	3) obstruction of the uterine tube
4) perihepatitis (Fitz-Hugh-Curtis syndrome)	4) pyosalpinx
5) inflammation of the chorion	5) hydrosalpinx
6) inflammation of the amnion	

hydrosalpinx and surrounding tissues. It has been proven that Chlamydia trachomatis infection is related to the onset of hydrosalpinx (Fig. 1).

## 2. Obstruction of the passage due to damage to the cells of the endosalpinx

When Chlamydia trachomatis from the cervix reaches the uterine tubes, it is possible to capture the transient process of destruction of the chorionic and secretory cells on the surface of the uterine duct by scanning electron microscopy. These cytological changes are transient and to repair the damage, the affected cells are soon replaced by new, robust cells. If exposed repeatedly to Chlamydia, however, irreversible changes may occur.

## 3. Proliferation of tubal collagen fibers caused by repeated infection

If a patient who is unaware of being infected with Chlamydia trachomatis continues to have sexual intercourse with a partner who has transmitted the disease, she will suffer from a chronic state of salpingitis for a prolonged period.

In an experimental infection using rats, in which the Fallopian tube were repeatedly infected with Chlamydia, sequential observation of the ducts revealed proliferation of the collagen fibers of the ductal tunica muscularis, which does not occur in a single infection. Consequently, it was confirmed that unlike its surface tunica intima, the Fallopian tube becomes

hypertrophic due to the proliferation of the tunica muscularis; and its lumen narrows, with the protruding muscular layer occupying the luminal space. This results in stenosis of the Fallopian tube and tubal pregnancy due to blockage of the fertilized ovum or eventual development of tubal sterility due to tubal obstruction.<sup>6)</sup>

## 4. Onset of peri-tubal adhesion

The development of ascites associated with Chlamydia infection has already been described. In such a condition, adhesion occurs not only at the fimbria of the Fallopian tube: it affects the tube itself as well as the surrounding tissue, robbing the tube of its mobility. The ovum that has been released fails to be arrested or transported in the Fallopian tube as intended, resulting in infertility of the individual.

## Prevention of Sterility Due to Chlamydia Infection

The symptoms—such as a sensation of having leukorrhea, abdominal pain, and pain during intercourse—are more frequently experienced; and adnexitis and pelviperitonitis are more likely to develop when the individual is exposed to a larger bacterial load. If so, the patient will seek medical care more willingly, the infection may be completely eradicated, and subsequent infertility successfully prevented by antibiotics to which the organism is sensitive (Table 3).

Table 4 Gyneco-obstetric Outpatients Who Should be Tested for Chlamydia Trachomatis Infection

No symptoms	Young women, in particular teenagers Women with multiple sexual partners Sexual partners with Chlamydia trachomatis infection
With symptoms	Sensation of having leukorrhea Lower abdominal pain Pain at intercourse Pain at internal examination

A problem exists in locating and treating those young women who have contracted the infection but are unaware of (and not seeking medical care for) their condition (such as pelvi-peritonitis). If left untreated, they will eventually become infertile. This condition can be averted by timely treatment if they go to a gyneco-obstetric department and get an appropriate medical examination (Table 4).

In addition to treatment, educating young women about the diseases that can be transmitted by sexual intercourse may be an important step for prevention.

### In Closing

The current trends for the younger segment of the population to engage in initial sexual acts and women delaying marriage and having families suggest a possible prolongation of the period during which women may engage in sexual intercourse with multiple partners.

To prevent sexually transmitted diseases during this period (which may last as long as 10 or 15 years), appropriate sex education is more important than any therapeutic measures that can be given after transmission.

The author wants to emphasize that sex education is needed for upper elementary school children that is presented in a rational and open atmosphere. Without taking more positive steps in this direction, it will not be possible to reduce the incidence of infertility among

young women.

### REFERENCES

- 1) Kawana, T.: New Infectious Disease Prevention Law: Venereal Diseases Prevention Law is abolished. *Obstetrical and Gynecological Practice* 1999; 48(8): 1043–1049. (in Japanese)
- 2) Kumamoto, Y. *et al.*: A survey on the status of the epidemic of sexually transmitted diseases (STD) in Japan — 2000 report on STD Sentinel Surveillance. *Japanese Journal of Sexually Transmitted Diseases* 2001; 12: 32–67. (in Japanese)
- 3) Kumamoto, Y. *et al.*: Sexually Transmitted Diseases Surveillance in Japan (Rate per 100,000/year by disease, age, and gender: 1998). *Japanese Journal of Sexually Transmitted Diseases* 1999; 10(1): 40–60. (in Japanese)
- 4) Sato, E., Hojo, T., Noguchi, Y. *et al.*: A case of Fitz-Hugh Curtis syndrome successfully treated for the right hypochondrium pain by adhesiotomy with laparoscopy. *Japanese Archives of Sexually Transmitted Diseases* 1998; 9(1): 65–69. (in Japanese)
- 5) Asai, K., Yamamoto, O., Fukahara, T. *et al.*: An experience with Fitz-Hugh-Curtis syndrome caused by Chlamydia trachomatis infection. *Japanese Journal of Gastroenterology* 1999; 96(8): 964–968. (in Japanese)
- 6) Noguchi, Y., Nakabe, K., Fujita, M. *et al.*: Pathohistological study of human Fallopian tubal damage by chronic salpingitis with *Chlamydia trachomatis*. *Japanese Journal of Sexually Transmitted Diseases* 1999; 10(1): 168–172. (in Japanese)

# Genital Herpes

JMAJ 45(12): 511–515, 2002

Michihito NIIMURA

*Professor, Department of Dermatology, The Jikei University School of Medicine*

**Abstract:** Among STDs, genital herpes ranks third in terms of the prevalence in Japan, after genital chlamydia infection and gonococcal infection. The most significant problem with this disease is its propensity for recurrence, which may cause both physical and mental distress to patients. Indeed, some people believe that a person, once infected with genital herpes, has to give up the idea of marrying, or that a woman with the disease cannot bear children. Such false propaganda should be checked. While antiviral agents such as acyclovir are extremely effective for the treatment of genital herpes, it must be remembered that these drugs are not cures in themselves. Continuous oral acyclovir suppression may be required for preventing frequent recurrences.

**Key words:** Genital herpes; Herpes simplex virus; Sexually transmitted disease

## Introduction

Genital herpes may be caused by herpes simplex virus type 1 (HSV-1) or herpes simplex virus type 2 (HSV-2). Both HSV-1 and HSV-2 infections may be associated with small vesicles, erosions, and shallow ulcers in the genital area. After the clinical course of the illness, the virus remains latent in certain nerve cells in the sacral ganglion, and causes repeated recurrence.<sup>1)</sup> HSV, which invades the skin and mucous membranes, may also cause keratitis, retinitis, encephalitis, encephalomyelitis, and even systemic infection in newborn babies or immunocompromised patients.

Several newly-developed drugs, including acyclovir, are effective in the treatment of

herpes. These drugs usually relieve the acute symptoms associated with genital herpes. However, reactivation of HSV cannot be prevented even by these potent drugs. Once infected with HSV, a person usually continues to experience recurrences throughout his/her lifetime.

Genital herpes is a sexually transmitted disease. The re-emergence of this disease in Japan may be associated with the change in people's views on sex. The percentage of teenagers engaging in sexual encounters has been on the increase, and the prevalence of genital herpes has been increasing, especially in the youth. Unfortunately, most people with genital herpes do not have symptoms, and these people may transmit the infection to their sexual partners even without their own knowledge. Further-

This article is a revised English version of a paper originally published in the Journal of the Japan Medical Association (Vol. 126, No. 9, 2001, pages 1149–1152).

more, when a person is diagnosed with genital herpes, and his/or her partner becomes aware of the risk of transmission of the infection, their personal relationship may be jeopardized. The patient himself/herself often feels guilty and wary.

### Epidemic of Genital Herpes

A sharp increase in the number of patients with genital herpes was observed in the United States between 1970 and 1980. The weekly "Time" magazine featured genital herpes on their cover, depicting the shadow of a man and woman standing face to face, with 'The Scarlet Letter' written in relief. "The Scarlet Letter" is a story illustrating the prevalence of adultery among Puritans in Boston in the 17th century. In Japan also, the print media have discussed the subject with sensational headlines. The result was that some people came to believe falsely that a person contracting genital herpes infection has to give up the idea of marrying, or that women, once infected with herpes, cannot bear children. In fact, a significant segment of the population with or without genital herpes panicked to the point of becoming neurotic.

Epidemiological data on the prevalence of genital herpes in our country are contained in the annual survey of sexually transmitted diseases in Japan initiated by the Ministry of Health and Welfare (MHW, now reorganized as the Ministry of Health, Labor and Welfare) in 1987. The survey covers patients with STDs who visited 606 pre-selected medical institutions across the country.<sup>2)</sup> According to the survey, approximately 6,000 new cases of genital herpes infection have been diagnosed annually since 1987. As to its prevalence in comparison with other STDs, genital herpes takes the third place, after genital chlamydia infection and gonococcal infection. Genital herpes infection is estimated to develop in 40 people per 100,000 every year. The incidence now appears constant, and has shown no tendency towards increase.

Another survey conducted in 1998 by the Infectious Diseases Sentinel Surveillance Workgroup, organized by the MHW, revealed that the annual morbidity rate of genital herpes infection in 7 model prefectures was 59.36 per 100,000 overall, being 36.20 in men and 81.63 in women. The ratio of women to men with the infection was 2.25.<sup>3)</sup> Based on these data, it is estimated that 22,000 men and 49,000 women suffer from genital herpes infection in Japan. In reality, however, a much larger number of people must suffer from HSV, considering that HSV infection is often asymptomatic.

### Clinical Problems Associated with Genital Herpes Infection

HSV infection is frequently asymptomatic. Adult genital herpes is usually transmitted by sexual intercourse. Symptoms of genital herpes may appear within 2 to 10 days after the infection, and consist of vesicles and erosions in the genital area. Primary infection in adult associated with acute symptoms such as fever, swollen regional lymph nodes, multiple vesicles, and erosions is often caused by HSV-1, which is transmitted from the mouth of a partner. In this type of infection, recurrence may be rare. In contrast, symptoms of HSV 2 infection are usually relatively mild, but recurrences are frequent.

The virus multiplies at the site of entry, and travels upward along the nerve endings at the site of infection to the sacral ganglia to enter a latent phase. Sexual intercourse, overwork, and stress may trigger recurrences. Recurrent genital herpes often manifests as 5 or 6 vesicles in isolation, which may resolve in 7 to 10 days' time, even without treatment. However, 6 or more recurrences per year are not rare. Multiple recurrences may cause deep depression in some people, with the need for professional counseling. The frequency of recurrence, however, may decrease gradually on its own after several years, with recurrent episodes eventually becoming rare. This infection is curable.

In the majority of patients, recurrences begin with warning signs or prodromal symptoms, including mild neuralgia, pain radiating to the thigh, dysphoria, or bladder irritation, before the vesicles eventually develop.

### **1. Decrease in the percentage of people carrying anti-HSV antibody**

Previously, most Japanese people became infected with HSV-1 during their childhood. Thus, when genital herpes infection occurred at sexual maturity, they had a much milder first clinical episode, because of the homology between HSV-1 and HSV-2, and immunological memory. With the society becoming increasingly cleanliness-oriented, however, the incidence of HSV-1 infection in early life has decreased. Currently, the percentage of people at the age of 20 who test positive for anti-HSV antibody is less than 50 percent.

HSV-1 and HSV-2 have much in common in terms of their antigenic profile. A person with anti-HSV-1 antibody may be less susceptible to HSV-2 infection. The upsurge in the number of young people with primary genital herpes infection presenting with acute severe symptoms may be due to the lower frequency of exposure to HSV-1 in childhood. The same may explain the increase in the number of cases with genital herpes caused by HSV-2. The decrease in the percentage of pregnant women carrying anti-HSV antibody may be associated with a higher risk of HSV infection in newborns, as they are less often protected by the antibody from the mother.

### **2. Asymptomatic viral shedding**

Asymptomatic viral shedding into vaginal secretions and semen is observed in most patients over time, resulting in asymptomatic transmission.<sup>4)</sup> Seventy percent of people with primary genital herpes infection are often those in whom the infection has been transmitted from a sexual partner without any overt symptoms.

### **3. Mother-to-child infection**

Transmission to newborns may occur at the time of delivery, if the mother has active genital herpes infection. The incidence of neonatal herpes in Japan is one in 10,000 to 20,000 births, but the prognosis is unfavorable, with early death occurring in approximately 30 percent of babies with neonatal herpes.<sup>5)</sup> The risk of a mother with primary genital herpes transmitting the infection during labor and delivery is rather high and is estimated to be 50 percent; on the other hand, the risk of a mother with recurrent herpes transmitting the infection is estimated to be 0 to 5 percent.

Since neonatal herpes simplex infection may not be associated with vesicles on the skin and mucous membranes in some cases, diagnosis is rather difficult to make, and a confirmatory virus culture and the polymerase chain reaction (PCR) must be carried out, if infection is suspected. When the results are positive for HSV infection, treatment with acyclovir should be initiated.

For infection occurring within one month of the expected date of delivery, a Cesarean section may be indicated. Acyclovir suppression during late pregnancy may also be effective.

### **4. Diagnosis of genital herpes**

Ulcerative lesions and vesicles on the external genitalia may be suggestive of genital herpes. The diagnosis is best established by viral culture and PCR. These techniques, however, are expensive and time-consuming. The more practical tests that can be performed are direct fluorescent antibody staining and the Tzanck test for detecting ballooned and multinucleated cells in smears of the fluid from the vesicles.<sup>6)</sup>

Serologic screening may not be useful for the diagnosis of herpes, since infected persons remain seronegative during the acute phase of the disease and turn positive only during convalescence. In addition, the serum antibody titers are variable, depending on whether or not the patient has recurrent herpes. Antibody



testing with glycoprotein G from the viral envelope can distinguish among the types of HSV, although the typing requiring expertise. The current prevalence of HSV-2 infection is 2.9 to 4.0 percent among men and 6.9 to 10.7 percent among women. These figures are lower than those from Western Europe and the United States.

### **Current Treatment**

Currently available antiviral drugs for treating herpes infection are effective for inhibiting the viral growth; however, these drugs cannot eliminate viruses in the latent phase, nor completely prevent recurrent episodes. For the treatment of primary genital herpes infection associated with severe local symptoms, acyclovir is administered orally at the dose of 200 mg 5 times daily for 5 days. In more severe cases, acyclovir is administered intravenously at the dose of 5 mg/kg, three times a day. Treatment with acyclovir administered either orally or intravenously can be continued for up to 7 to 10 days depending on the clinical condition of the patient.

For the treatment of recurrent episodes of HSV, oral administration of acyclovir at the dose of 200 mg five times daily for 5 days is effective. Since earlier use during the clinical course may suppress recurrent episodes more effectively, the medication should be started at the time of occurrence of prodromal symptoms such as dysphoria and neuralgia. In milder cases, topical acyclovir ointment or vidarabine may be used several times daily.

### **Future Treatment**

For patients with 6 or more recurrent episodes of genital herpes per year, continuous oral antiviral suppression is recommended by the Centers for Disease Control (CDC) in the United States, in order to relieve the mental distress of the patient and prevent transmission to others.<sup>7)</sup> Continuous use of acyclovir tablets,

400 mg twice daily, suppresses recurrent episodes. Such use of acyclovir, however, is not reimbursed by the national health insurance in our country. Until now, oral acyclovir has not been reported to cause any significant adverse effects, even after several years of use. The emergence of resistant strains to acyclovir has not posed a significant problem in immunocompetent patients; however, foscarnet, rather than acyclovir, should be administered in patients with the acquired immunodeficiency syndrome (AIDS), or to patients who have undergone organ transplantation, in order to avoid the emergence of acyclovir-resistant strains due to long-term administration.

HSV vaccines under development are still far from satisfactory. Some immunomodulating agents for topical external use have been reported to be effective in the prevention of recurrent genital herpes.

### **Preventive Measures against the Spread of Genital Herpes**

Earlier sex education with provision of accurate information about sexually transmitted diseases is useful. The necessity of using a condom during sexual intercourse in order to avoid transmission to the partner, should be stressed in patients with vesicles or ulcerative lesions in the genital area. Considering that asymptomatic shedding is common, however, it is desirable to advocate the use of condoms even to those with the inactive phases of the infection, except when the couple wants to have a baby. CDC recommends the use of condoms even when the patient is on continuous oral antiviral suppression. The use of condoms alone is not completely safe though, since lesions may also occur in the anal region, buttocks, or thigh.

Correct information about STDs and the importance of the proper use of condoms should be conveyed through sex education in order to prevent the spread of STDs, including genital herpes. Complete eradication, however,

of HSV, which has survived in humans for several million years, may not be possible.

#### REFERENCES

- 1) Nahmias, A.J. and Roizman, B.: Infection with herpes simplex viruses 1 and 2. *N Engl J Med* 1973; 289: 667–674.
- 2) Kumamoto, Y., Tsukamoto, T., Nishiya, I. *et al.*: Sexually transmitted diseases surveillance in Japan. *Nihon Seikansensho Gakkaishi (Japanese Journal of Sexually Transmitted Diseases)* 1999; 10(1): 40–60. (in Japanese)
- 3) Kumamoto, Y., Tsukamoto, T., Nishiya, I. *et al.*: Epidemiological survey of sexually transmitted disease prevalence in Japan. *Nihon Seikansensho Gakkaishi (Japanese Journal of Sexually Transmitted Diseases)* 2000; 11(1): 72–103. (in Japanese)
- 4) Rooney, J.F., Felser, J.M., Ostrove, J.M. *et al.*: Acquisition of genital herpes from an asymptomatic sexual partner. *N Engl J Med* 1986; 314: 1561–1564.
- 5) Morishima, T., Kawana, T., Hirayama, M. *et al.*: National survey on neonatal herpes. *Nihon Shonika Gakkai Zasshi* 1989; 93: 1990–1995. (in Japanese)
- 6) Kawana, T., Kurata, T., Sata, T. *et al.*: Diagnosis of herpes simplex infection using fluorescence-labelling monoclonal antibody (Micro-Trak Herpes). *Kansensho Gakkai Zasshi* 1987; 61: 1030–1037. (in Japanese)
- 7) Centers for Disease Control and Prevention (CDC), 1998 guidelines for treatment of sexually transmitted diseases. *MMWR* 1998; 47: 22–26.

# Current Status of *Trichomonas vaginalis* Infection, a Sexually Transmitted Disease

JMAJ 45(12): 516–519, 2002

Nobuo KAWAMURA

Professor, Department of Urology, School of Medicine, Tokai University

**Abstract:** *Trichomonas vaginalis* usually induces urethritis in men and vaginitis in women, but it may remain inapparent in some. We observed an inapparent infection lasting as long as 1,311 days in a male patient. *Trichomonas vaginalis* in vaginal secretion is detected microscopically, but urine must be cultured for detection. The detection rate of *Trichomonas vaginalis* in men between 1991 and 1998 was 0.7%, with an increasing tendency from 1999 onward to 6.1%. Metronidazole or Tinidazole is used for treatment. Partners should be treated simultaneously, but men respond better to treatment. *Trichomonas vaginalis* seems to live in the prostate or the seminal vesicle, its presence being assumed by its fructose decomposition.

**Key words:** *Trichomonas vaginalis*; Urogenital infections in male; Nongonococcal urethritis

## Introduction

*Trichomonas vaginalis* (TV) is a pathogen for sexually transmitted disease (STD), is spread by men, causes vaginitis in women, and nongonococcal urethritis in men occasionally.<sup>1)</sup> Infections are sometimes inapparent or asymptomatic, and transient in men.<sup>2)</sup>

TV is a protozoa belonging to mastigophora. It is gourd shaped, has an undulating membrane and 3 to 5 flagella, is active under favorable conditions, and therefore easily identified microscopically (Fig. 1). Under unfavorable conditions, it becomes spherical or piriform, and immobile. In such a state, culture should

be carried out so that it becomes mobile for identification.

Commercially available Nissui culture medium is used. If *Candida* is present, protozoa detection will be difficult. Instructions for culturing suggests microscopy on the seventh day, but a better result is obtainable on the 10th day if the number of protozoa is small.<sup>3)</sup>

The only statistic that teaches the percentage of TV detection from non-gonococcal urethritis is obsolete, and it is questionable whether nongonococcal urethritis was caused by TV alone since there were no methods in those days for detecting Chlamydia, Mycoplasma, Ureaplasma, etc.<sup>1)</sup> The rate of inapparent infection

This article is a revised English version of a paper originally published in the Journal of the Japan Medical Association (Vol. 126, No. 9, 2001, pages 1153–1155).

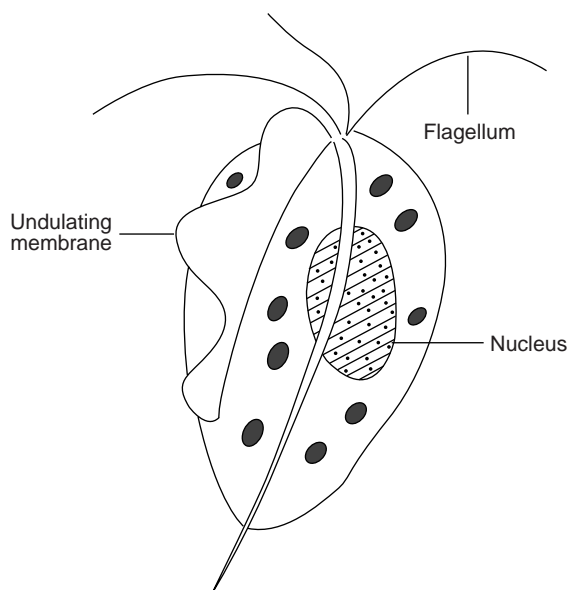

Fig. 1 Schematic drawing of *trichomonas vaginalis*

among Japanese is also not known. The data on prisoners is available, but it is not applicable to the general population, since all the subjects have criminal records and different social backgrounds from the general public.<sup>2)</sup>

The author attempted to detect TV from male in-patients, and found TV in less than 20% of the married men (aged 20 to 40) who were scheduled for surgery. At that time, TV infection rate in women was also high, suggesting that women without grave symptoms have had sex prior to admission for small surgery such as removal of ureteral stones. In such patients, TV disappeared within 3 to 7 days, except for elderly patients. These facts suggest that there were two types of infections, extended and transient. On the other hand, TV was detected in less than 70% of the husbands whose wives had TV infection, whereas it was detected in 100% of the wives of the husbands with TV infection. It is thus assumed that TV is less likely to reside in men and more likely to induce permanent infection in women. There are no recent publications on the TV infection rate among Japanese women, but the rate is said to have decreased drastically.

Table 1 Period of *Trichomonas Vaginalis* Infection in Men (Study on prisoners)

Period of infection (days)	Age	Period of infection (days)	Age
1,311	56	605	28
1,204	64	407	45
1,140	35	400	32
1,094	47	381	30
889	41	358	63
803	39	351	36
793	50	346	43
772	28	333	54
755	46	333	56
714	50	329	66
700	27	325	44
617	41		

- 200–300 days Four (4) men
- 100–200 days Five (5) men
- Less than 100 days 12 men

If untreated, infections apparently continue in female patients even when they become older or have hysterectomy, whereas men are cured naturally or continue as inapparent infection. A prisoner had the infection lasting as long as for 1,311 days (Table 1).<sup>2)</sup>

### Current Status

TV detection rate in men between January 1991 and December 1998 was 0.7%, but it rose to 6.1% between January 1999 and May 2001. Prior to the survey period, it was 3.43% indicating that the transmission rate was quite low in the beginning of 1990s. This was the period of so-called AIDS shock in Japan, and the ratio seems to have risen as the public has recovered from the shock.

TV is detected by culture. Our method detects TV without fail if there are two or more live protozoa. We rarely test the partner, since

patients visit our clinic because they have had an opportunity for contracting STD and usually have no permanent partner whom they would accompany to the clinic. Only occasionally, an asymptomatic partner comes to the clinic when she learns of TV infection.

Samples other than urine are used for detection, but semen samples are difficult to test as they seem to change pH of the culture. TV is often detected in urine after prostatic massage, but since fewer cases are diagnosed recently as chronic prostatitis, the number of examinations has also decreased. Five (1.5%) out of 335 samples tested positive. In one case, TV was detected in hydrocele testis fluid. Culture of hydrocele testis in adults revealed that one out of 18 tested positive.

TV is microscopically detected in women's vaginal discharge, probably due to a greater number of infected protozoa than men, but is rarely detected in men's urine sediments. When the centrifugal rotational speed exceeds 2,000 rpm, cilia are detached, making determination difficult. Non-centrifuged urine samples are therefore more suitable as specimen. When TV is detected in a woman's urine, her vagina is also infected. There is no case of infection of the bladder alone.

## Treatments

Treating TV in men is simple, especially with oral agents. Those available in Japan are Metronidazole and Tinidazole; the former is administered at 500 mg/twice/day for 10 days or 1.0–1.5 g is single dosed. The latter is administered 400 mg/twice/day for 7 days or 2.0 g is single dosed.<sup>4,5)</sup>

Recurrence occurs if the partner is infected. If TV is detected, the spouse should be treated simultaneously for the same period.

Local therapeutic agent such as vaginal tablet can be given to women concurrently with an oral agent. Generally speaking, it is more difficult to cure women and they are more susceptible to relapses. This may be attributable to

more nutrients for TV present in the vagina. No recent data on the rate of cure for Japanese women is available.

Relapses often occur in women, but hardly in men. Women should be examined for relapse 1 to 4 weeks after treatment. Since TV infection is a STD, patients should be tested and treated for other pathogens if they tested positive for TV. Although no detailed study has been conducted on the time leading to onset, TV may be detected the next day of exposure. The period to onset for men is usually 10 to 14 days although it can be shorter if greater numbers of protozoa are present. No data is available for women. We therefore do not recommend testing other STDs immediately after TV detection. Timing depends on the time elapsed from exposure. An urethritis male patient should be tested for gonococcus or chlamydia trachomatis since they cause inflammation more easily. Treatment should be started with a potent drug, leaving treatment of TV to the last.

In men, TV may be resident in the prostate or the seminal vesicle. Resident mitotic proliferation occurs more easily in the male auxiliary genital organs. Rats were used for *in vivo* tests on extended viability and fructose containing culture for *in vivo* test.<sup>6)</sup> Fructose decreased with protozoa increase in the fructose containing culture.

The above going suggests that TV is viable on fructose as a nutrient source, and TV infection in male auxiliary genital organs can occur since fructose is present in the seminal vesicle and the prostate. This is evidenced by long-term inapparent infection and decreased fructose in the rat prostate inoculated with TV.<sup>6)</sup>

TV as a sexually transmitted disease was discussed urologically.

## REFERENCES

- 1) Kawamura, N.: Study on *trichomonas vaginalis* in the urological field — 1. *Jap J Urology* 1969; 60(1): 15–24. (in Japanese)
- 2) Kawamura, N. and Kinoshita, H.: The inci-

dence of *trichomonas vaginalis* infections and the length of asymptomatic infections among male prisoners in a reformatory. *Acta Urol Jap* 1979; 25: 1023–1025.

- 3) Asami, K.: Bacterial-free cultivation of *trichomonas vaginalis*. *Kitasato Arch Exp Med* 1952; 25: 149–156.
- 4) Kawamura, N.: Study on *trichomonas vaginalis* in the urological field – 6. Examination of

clinical therapeutic effects of various drugs. *Jap J Urology* 1973; 64: 281–286. (in Japanese)

- 5) Kawamura, N.: Metronidazole and Tinidazole in a single large dose for treating urogenital infections with *trichomonas vaginalis*. *Brit J Vener Dis* 1978; 54: 81–83.
- 6) Kawamura, N.: Study on *trichomonas vaginalis* in the urological field – 3. *Jap J Urology* 1969; 60(1): 29–35. (in Japanese)

# Sexual Practices and the Risk for HIV/STDs Infection of Youth in Japan

JMAJ 45(12): 520–525, 2002

Masako ONO-KIHARA\*, Masahiro KIHARA\*\* and Hiroshi YAMAZAKI\*\*\*

\*Assistant Professor, Department of Public Health,  
Hiroshima University School of Medicine

\*\*Professor and \*\*\*Lecturer, Department of Global Health and Socio-epidemiology,  
Kyoto University School of Public Health

**Abstract:** With the beginning of the twenty-first century, the spread of sexually transmitted infections, especially HIV, is expected to rise, particularly among youth in Japan. We have carried out a series of nationwide surveys to identify sexual behavior of Japanese youth. The results indicate that the sexual behavior of Japanese youth is drastically changing. They tend to increasingly engage in first coitus at an earlier age, perform more oral sex, and participate in more sex with casual friends or multiple partners. Among young couples in downtown Tokyo, those who have had over five sex partners ranked the second only after those who have had a single partner. This indicates that young people's sexual networks have become highly expansive and interwoven. We have also found that Japanese youth are actively involved in paid sex, at a rate nearly ten times that of their Western counterparts. As a corollary of this situation, the abortion rate of teenagers has doubled and the number of chlamydia and gonorrhea cases among youth has also increased since 1995. Changing the sexual behaviors of Japanese youth is the key to curb the expected HIV epidemic in Japan. To accomplish this, we must urgently develop culturally appropriate HIV prevention measures, following the thorough examinations of the current sexual behaviors of youth in Japan.

**Key words:** Youth; Sexual network; HIV; Sexually transmitted diseases (STDs)

## Introduction

With the beginning of the 21st century, concern is growing over the possible outbreak of sexually transmitted infections, including

HIV/AIDS, particularly among youth in Japan. Our study group (the Study Group for Socio-epidemiological Studies on Monitoring and Prevention of HIV/AIDS), sponsored by the Ministry of Health & Welfare, has conducted a

---

This article is a revised English version of a paper originally published in the Journal of the Japan Medical Association (Vol. 126, No. 9, 2001, pages 1157–1160).

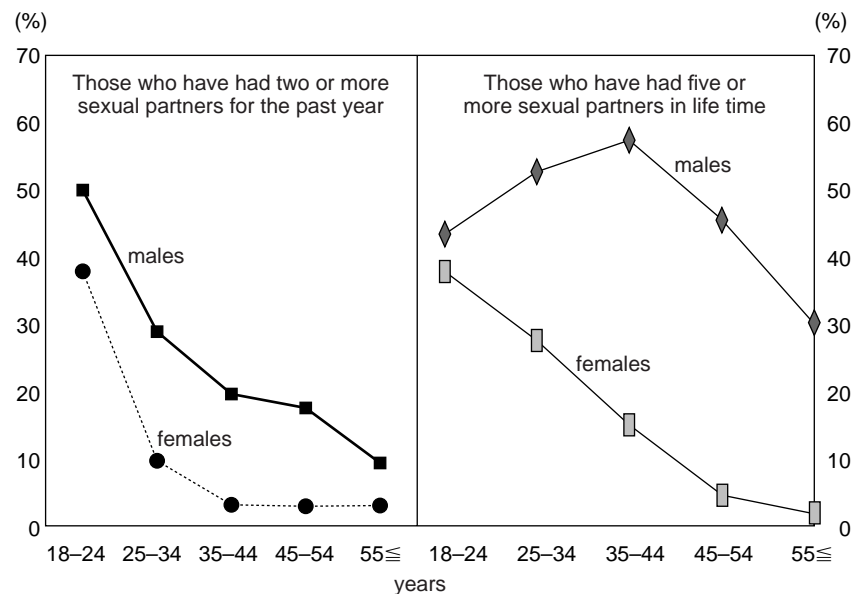

Fig. 1 Sexual behaviors according to age groups (based on the nationwide survey)

nationwide survey since 1999 to discern the characteristics of sexual behavior among sexually active populations in Japan. This paper outlines the results of the surveys, giving a particular focus on youth. Based on the results, we argue for the urgent need of introducing prevention measures for HIV and sexually transmitted diseases (STDs) among youth which are culturally appropriate for the target population.

### Current Status and Characteristics of Sexual Behaviors among Japanese Youth

The Japanese Association of Sex Education and the Tokyo Study Group on Sex Education for Kindergartens, Primary Schools, Junior/Senior High Schools, and Schools for Mentally Handicapped (JAE/TSG) have conducted periodic surveys on sexuality of the students of selected schools and universities since 1985, disclosing valuable information such as initiation of sexual intercourse becoming younger rapidly over the last decade among the target group.<sup>1,2)</sup> However, only limited information in terms of

HIV/STDs risk assessment has been provided from these surveys. It is this background that we carried out the first nationwide survey in 1999 on sexual behavior with 5,000 random samples aged 18–59 (3,562 participated with 71.2% response rate).<sup>3)</sup>

According to the survey, we found that the sexual behaviors of Japanese youth has undergone drastic changes. They tend to increasingly engage in first coitus at an earlier age, perform more oral sex, and participate in more sex with casual friends or multiple partners (Fig. 1). We also witnessed diversification of their sex partners and sexual practices (more oral sex), earlier initiation of sexual practices, and a greater involvement in paid sex. Except for paid sex, these changes appeared more pronounced in women, diminishing the gap or reversing the ratio that existed between the two genders.

Those who engage in paid sex accounted for over 10% on an average and 15 to 19% for youth. Since this population in other developed countries only adds up to 1 to 2% at most, Japan certainly stands out as an exception for this matter. The Japanese case is rather similar to that of other Asian nations. The survey also



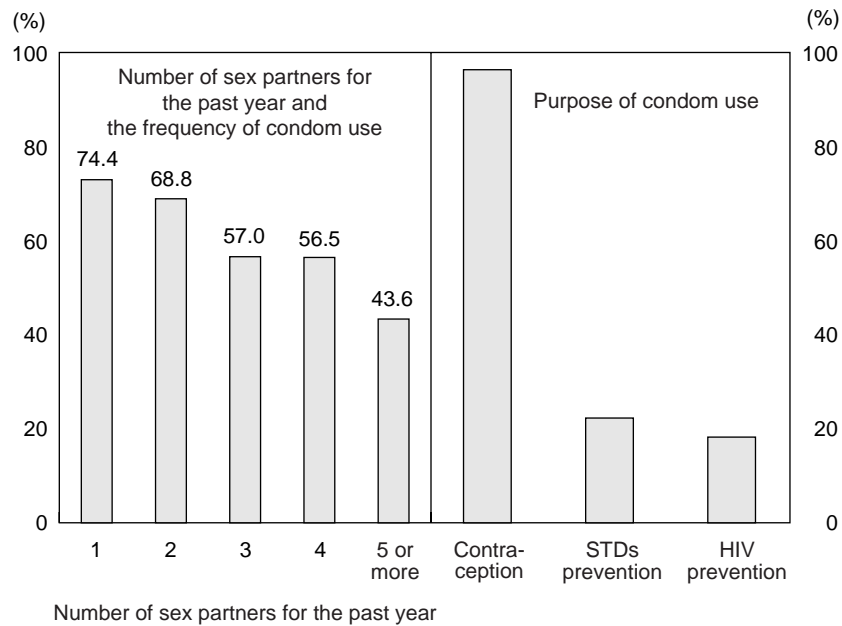

Fig. 2 Condom use and its purpose among students of national universities

revealed that the Japanese youth are quite ignorant about HIV/STDs (Many are unaware, for example, that STDs infection could occur by oral sex, or that those infected with STDs are more susceptible to HIV infection).

In the same year our study group carried out another survey entitled “Sexual Health Study for Students of National Universities (13,645 participated among 26 out of 96 universities with 57.5% response rate) to identify the sexual behavior of Japanese youth in their late teens and early twenties.<sup>4)</sup> The result showed that 70% of the respondents used condoms for their last sex irrespective of grade or gender, and over 90% of them regarded condoms as a tool for contraception while less than 20% regarded it as a preventive measure for HIV/STDs infection (Fig. 2). Over 70% of the respondents answered that they used condom with their regular partner regularly while less than 50% used it with their casual partners. Those who had more partners used condoms less frequently (Fig. 2), indicating their very limited perception of HIV/STDs risk. In terms of sexual practices, only 6 to 7% used condom for oral sex, perhaps

reflecting their limited knowledge regarding STDs transmission via oral sex.

In 2000, we further conducted a survey on sexual behavior of teenage couples in downtown Tokyo<sup>5)</sup> (time-space sampling; 301 couples). Unlike conventional surveys, the responses of these respective couples are linked so as to gain insight into their sexual network. The most prevalent combination was both sides having had one sex partner, which nevertheless accounted for merely 17% of all the couples. The second most frequently observed combination was both sides having had over five sex partners (Fig. 3). These outcomes suggested that teenage couples in the metropolitan area have developed a highly interwoven sexual network.

Urban youth are often singled out as those more likely to harbor risks for HIV/STDs transmission. There was, however, no evidence in Japan, whether or not sexual behaviors of teenagers in rural areas is indeed less susceptible to HIV/STD infection. Our survey conducted on second grade high school students at one of provincial prefectures in western Japan in 2001 revealed otherwise<sup>6)</sup> (4,552 participated

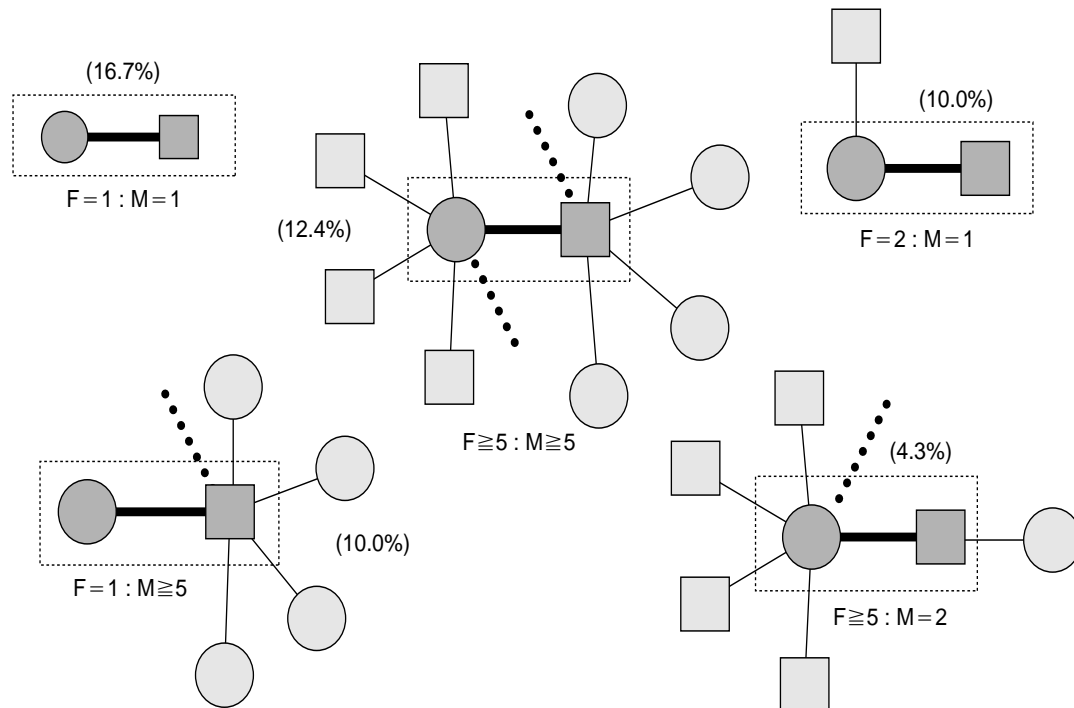

Fig. 3 Patterns of sexual networks among 231 teenage couples in Metropolitan Tokyo  
 \*Circle and square stand for female(F) and male(M), respectively, with dark ones representing survey participants and light ones their concurrent and/or past partners.

among 33 out of 86 high schools with 99% response rate). The survey results indicated that approximately 30% of both male and female second year students had experienced sex. This outcome largely coincides with those of the periodical surveys conducted by the KAE/TSG. Only less than 50% of sexually active respondents answered that they have had a single sex partner, indicating that rural youth are not necessarily sexually inactive compared to their urban counterparts. Moreover, their awareness toward STD prevention turned out to be quite limited; only 20% of the respondents used condoms regularly for sexual intercourse. These results reveal that the sexual behavior of teens in the provinces is also unsafe in terms of HIV/STDs prevention.

### Increase of STD/HIV Infection and Abortion Rate among Youth

As discussed above, Japanese people, espe-

cially youths, have become highly sexually active in recent years, expanding their sexual network and becoming increasingly vulnerable to HIV/STDs infection. Since 1995, rapid increases of chlamydial infection among women and gonococcal infection among men have been reported.<sup>7)</sup> Although the abortion rate has dropped or reached a plateau among all women, that among teenagers has sharply risen after 1995, doubling in the last five years.<sup>8)</sup> As a corollary, the reported cases of HIV infection among youth by sexual contact are rapidly increasing both among homosexuals and heterosexuals, regardless of their gender.<sup>9)</sup>

The STDs epidemic deserves greater consideration, particularly in view of the AIDS epidemic. According to the HIV Prevention Strategic Plan published recently by the Centers for Disease Control and Prevention (USA),<sup>10)</sup> ulcerative STDs increase the risk for HIV infection per sexual exposure by ten to a few hundred times and for nonulcerative STDs by

two-fold to five-fold. HIV carriers infected with other STDs, may also augment the risk of HIV transmission since the shedding load could be higher relative to those without STDs. This synergistic cycle of HIV/STDs transmission could accelerate the HIV epidemic. The simultaneous increase in both STDs and HIV infection in Japan may therefore trigger this synergism and lead to a full-blown HIV epidemic in the 21st century, if no immediate action is taken.

### Key Elements for Prevention Intervention

From the discussion so far, it is obvious that the current trends in sexual behavior in Japan are leading the country into an increasingly vulnerable situation with regard to the HIV epidemic. Whether or not we succeed in controlling this trend (triggering behavioral changes towards safer sex) will determine the future magnitude of HIV epidemic in this society. But, how should we go about inducing behavioral changes? Unfortunately, existing prevention activities offer few prospects for the future of HIV prevention in Japan. Activities such as circulating leaflets and posters, giving lectures, and hosting HIV-related cultural events, which only aim to increase knowledge, have proven unsuccessful in countries that experienced the HIV epidemic in 1980s. If such failures are the repeated in Japan, so, too, will the epidemic.

The key elements in improving future prevention intervention include theories, cultural sensitivity, partnership, and evaluation, all having been lacking from HIV prevention programs in Japan.<sup>11-13)</sup> Theories help to provide frame work and meaning to the program and thus enable evaluation. Cultural sensitivity and partnership help program to shift of perspective from top-down to bottom-up. Instead of authorities handing down the information that they think are appropriate in a didactic manner, the development of prevention measures

should be centered directly on those who face the risk of HIV infection. The best possible measures emanate from knowing the culture, lifestyle, language, and values of the target groups.

Evaluation is also essential to reach this goal since ineffective measures will be reproduced unless their effectiveness is assessed. Japan needs to move quickly in order to mobilize both political commitment and available resources to develop and implement HIV/STDs prevention program equipped with these key elements.

### REFERENCES

- 1) Japanese Association of Sex Education: *Report on the Fifth Survey on Students of Junior/Senior High Schools, Colleges and Universities*. 2000. (in Japanese)
- 2) Tokyo Study Group on Sex Education at Kindergartens, Primary Schools, Junior and Senior High Schools: *1999 Survey—Sex among Pupils and Students*. Gakko Tosho, 2000. (in Japanese)
- 3) Kihara, M., Kihara, M-O., Uchino, H. *et al.*: *National Study on HIV/STD Related Knowledge, Sexual Behavior, Sexual Awareness of the Japanese (Yearbook of Questionnaire Surveys on Education)*, Vol. 2. Souikusha, Tokyo, 2000; 117–135. (in Japanese)
- 4) Kihara, M-O. *et al.*: *Sexual Behaviors of College/University Students—Sexual Health Study for Students of National Universities*. Sankosha, Tokyo, 2001. (in Japanese)
- 5) Kihara, M-O. *et al.*: *Sexual Behavior of Teenage Couples in downtown Tokyo*. Study Group for Socio-epidemiological Studies on Monitoring and Prevention of HIV/AIDS, Ministry of Health, Labor and Welfare. *2000 Annual Report*. 2001. (in Japanese)
- 6) Kihara, M-O. *et al.*: *Survey on Sexual Behavior among High School Students in Provincial Prefecture*. Study Group for Socio-epidemiological Studies on Monitoring and Prevention of HIV/AIDS, Ministry of Health, Labor and Welfare. *2001 Annual Report*. 2002. (in Japanese)

- 7) Kumamoto, E. *et al.*: 1998 Report on the Fact-finding-study on STD in Japan (Breakdown by disease, sex, age and incidence per 100,000). *Jap J STD* 1999; 10(1): 40–60. (in Japanese)
- 8) Maternal and Child Health Division, Family Affairs Bureau, Ministry of Health, Labor and Welfare (ed.): *Major Statistics of Maternal and Child Health*. Maternal and Child Health Agency, Tokyo, 1992–2000. (in Japanese)
- 9) Ministry of Health, Labor and Welfare Committee on AIDS Trend; *Annual Report on AIDS Development and Trend, 2000*. (in Japanese)
- 10) Centers for Disease Control and Prevention: *HIV Prevention Strategic Plan Through 2005*. 2001.
- 11) UNAIDS: *Sexual Behavioral Change for HIV – Where Have Theories Taken Us?* UNAIDS/99.27E, 1999.
- 12) Kalichman, S.C.: *Preventing AIDS: A Sourcebook for Behavioral Intervention*. Lawrence Erlbaum Association, London, 1998.
- 13) DiClemente, R.J. and Peterson, J.L. (eds.): *Preventing AIDS: Theories and Methods of Behavioral Interventions*. Plenum, New York, 1994.

# Extrahepatic Manifestation in Hepatitis C

JMAJ 45(12): 526–531, 2002

Hidetsugu SAITO

*Assistant Professor, Department of Internal Medicine,  
School of Medicine, Keio University*

**Abstract:** Extrahepatic manifestations in chronic hepatitis C virus (HCV) infection are described. Cryoglobulinemia and vasculitis have been observed as frequent complications of chronic HCV infection. Similarly membranoproliferative glomerulonephritis and autoimmunity have also been reported. Autoimmune hepatitis occasionally develops after HCV infection. Molecular mimicry between autoantigens and HCV-related antigens has been postulated as the causative factor in some cases. Other clinical manifestations of autoimmunity such as thyroiditis, polymyositis, dermatomyositis, Sjögren's syndrome, and idiopathic thrombocytopenic purpura (ITP) are often reported. One of the causes for the development of autoimmunity in chronic HCV infection might be due to lymphotropism of HCV. Perihepatic lymphadenopathy and B cell-type non-Hodgkin lymphoma have been reported to have a possible correlation with chronic HCV infection. Since minus-strand HCV RNA has been detected in platelets and cardiomyocytes, it has been postulated that there is extrahepatic HCV infection of these tissues. Malignancies and lichen planus in the oral cavity are also frequently observed in patients with chronic HCV infection. All of these clinical manifestations have been observed through careful detailed medical examinations of all body systems and continuing this approach will facilitate the discovery of new disease entities in the future.

**Key words:** Hepatitis C virus; Autoimmunity; Cytokine; Infection

## Introduction

In acute viral hepatitis, viral infection causes damage mainly to hepatocytes, leading to symptoms specific to hepatitis such as fever, anorexia, nausea, and jaundice. However, other atypical symptoms of hepatitis are some-

times found and these are called extrahepatic manifestations.

Hepatitis C virus (HCV) was discovered by a venture company in 1989, which has been assumed for a long time causing post-transfusion hepatitis. During the decade since that discovery, studies on various liver diseases have

---

This article is a revised English version of a paper originally published in the Journal of the Japan Medical Association (Vol. 125, No. 10, 2000, pages 1593–1598). The Japanese text is a transcript of a lecture originally aired on December 8, 2000, by the Nihon Shortwave Broadcasting Co., Ltd., in its regular program "Special Course in Medicine".

progressed rapidly with the advances in biotechnology. As a result, a molecular biological approach has enabled researchers to find HCV more often in organs other than the liver. However, it is still unclear whether HCV detected by the polymerase chain reaction (PCR) method really causes damage to the organ from which HCV is detected.

Extrahepatic manifestations are caused not only by HCV, but also by other viruses. HAV and HBV induce various dermal symptoms in the early period of the first infection. Among them, Gianotti-Crosti disease combining papular peripheral dermatitis with acute hepatitis B is well known. Extrahepatic manifestations such as membranous nephropathy (reportedly caused by the deposition of immunocomplex of virus and immunoglobulin on the glomerulus), arteritis nodosa, and cryoglobulinemia have been recognized.

Some researchers have recently insisted that those manifestations are caused only by HCV in a mixed infection of HCV and HBV, although proof of this hypothesis has been difficult.<sup>1)</sup> On the other hand, a recent report has shown that cryoglobulinemia and nephropathy were cured by disinfection of HBV with Lamivudine, a virucide. Therefore, extrahepatic manifestations may be attributed to either of HBV or HCV.

### **Cryoglobulinemia**

Cryoglobulinemia is most frequently observed among HCV-infected patients. In cryoglobulinemia, immunoglobulins in blood that precipitate out when the serum is stored under 37°C, the average body temperature. This precipitation is redissolved by heating. Among the various types of globulin, type II consisting of polyclonal IgG and monoclonal IgM is most frequently observed.

We detected cryoglobulin in approximately 35% of chronic hepatitis C and cirrhosis patients. Most of them had advanced hepatic diseases. Cryoglobulin requires careful procedures for detection. It is detected most effectively by

observing precipitation in a sample kept at 4°C for 3 days after coagulation and centrifugation at 37°C.

HCV RNA can be detected from the precipitate of cryoglobulin collected by this method (called cryoprecipitate) employing RT-PCR analysis. Moreover, concentrations of HCV RNA in the cryoprecipitate, which exceed the levels in serum can be established by a competitive RT-PCR analysis.<sup>1)</sup> Namely, this cryoprecipitate is believed to be an immunocomplex of HCV as an antigen and immunoglobulin.<sup>2)</sup>

### **Vasculitis**

Many patients with cryoglobulinemia (40–95%) present with purpura. Although it is pathologically dermal vasculitis, other symptoms such as crus ulcer, papule, pustule, pigmentation are also found, and arthralgia and Raynaud's phenomenon are sometimes observed. Since these symptoms appear more frequently during the cold season, we persuade cryoglobulin-positive patients to protect themselves from the cold. Those symptoms are caused by precipitation of cryoglobulin on the vascular wall. Its precipitation on the glomerulus sometimes causes membranoproliferative glomerulonephritis. The decrease in the levels of not C3 but C4 and CH50 are observed in serum complement activity.

Those vascular manifestations can also be partly attributed to autoimmunity. Some researchers insist that hepatitis C induces autoimmune phenomena, is the leading cause of frequent episodes of cutaneous vasculitis and periarteritis. Many of the patients with hepatitis C seem to present with dermal symptoms such as urticaria, which may be related to vascular symptoms.

### **Autoimmunity**

In chronic hepatitis, the leakage of cellular components due to persistent destruction of cells may be one of the causes of production of

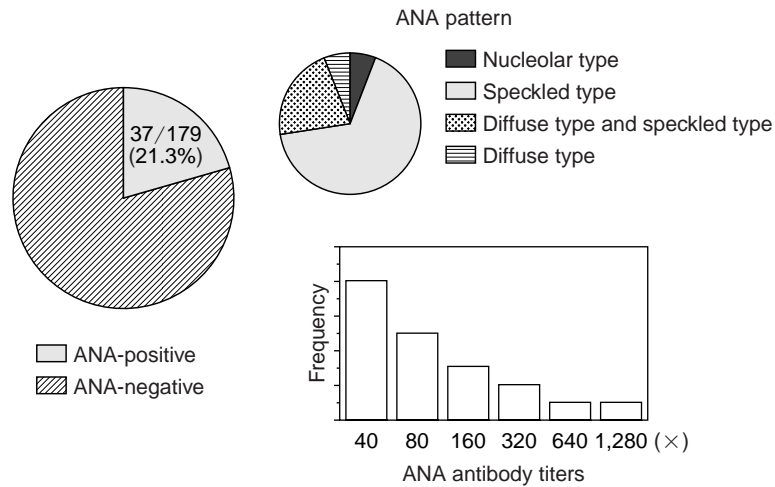

Fig. 1 Positive rate, patterns and distribution of antibody titers of antinuclear antibody (ANA) of 179 hepatitis C cases

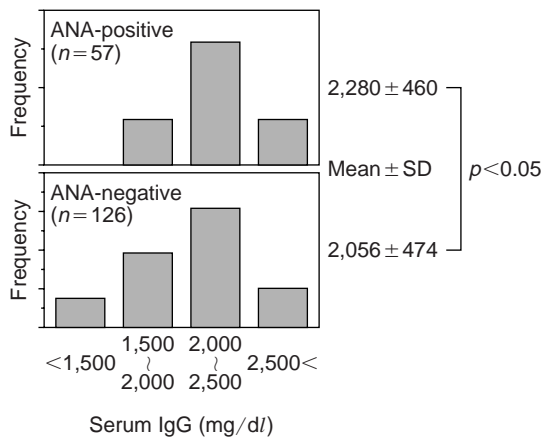

Fig. 2 Distribution of serum IgG values in patients with chronic hepatitis C

autoantibodies. About 20% of patients with hepatitis C are ANA-positive (Fig. 1), which can result from persistent destruction of cells. Furthermore, some researchers insist that viral infection induces autoimmunity.<sup>3)</sup>

One of the possible reasons is that viral infection induces the appearance of autoantibodies because of the molecular mimicry between HCV and autoantigens. LKM-1 antibody, observed in autoimmune hepatitis, is sometimes observed in chronic hepatitis C. This can be attributed to the mechanism of

molecular mimicry, in which the immune response to HCV induces cross-reactivity against autoantigens.

In our study, among a group of patients with chronic hepatitis C, high titers of ANA and significantly high levels of immunoglobulin were observed (Fig. 2). According to autoimmune hepatitis score (AIH score),<sup>4)</sup> not small cases can be diagnosed as definite autoimmune hepatitis. These patients are often females and having high staging (fibrotic) scores. They are characterized by their poor response to interferon treatment irrespective of the genotype, despite a low viral load (Fig. 3).<sup>5)</sup> Therefore, this phenomenon is one of the reasons why HCV-positive patients are included in the Japanese diagnostic criteria of autoimmune hepatitis.<sup>5)</sup> It is still possible that those patients initially suffer from autoimmune hepatitis and then, they receive HCV infection afterwards.

Similarly, it has been reported that autoimmune thyroiditis,<sup>6)</sup> polymyositis, dermatomyositis,<sup>7)</sup> Sjögren's syndrome, and idiopathic thrombocytopenic purpura (ITP) are frequently seen, or are exacerbated, following interferon treatment in patients with chronic hepatitis C. Sjögren's syndrome is considered to be clearly linked with HCV infection because sialadenitis

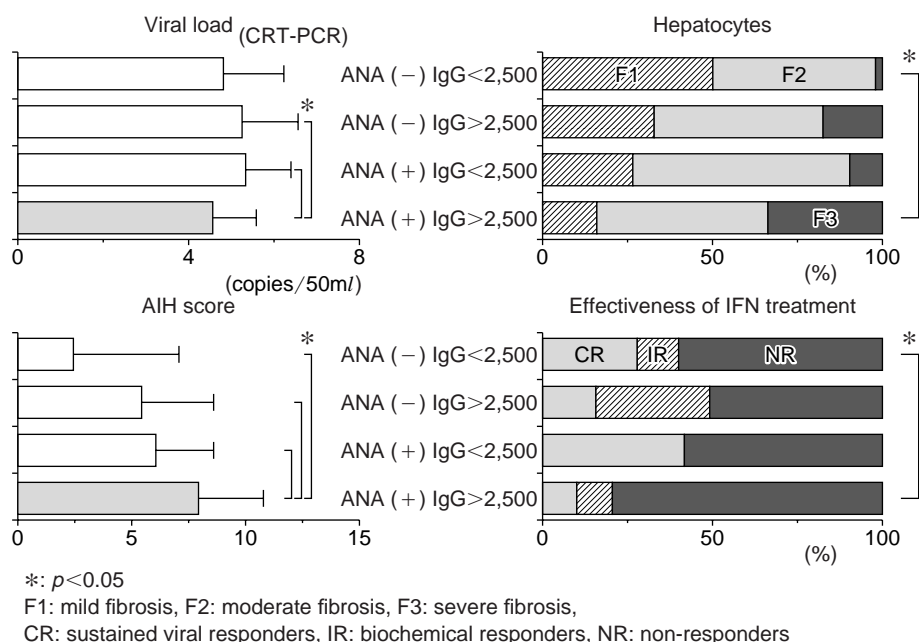

Fig. 3 Clinical features in each group classified by the existence or absence of antinuclear antibody (ANA) and serum IgG

was observed in an animal model produced by Koike *et al.* (transgenic mice with the outermost envelope of HCV).<sup>8)</sup> Although the relationship of other types of autoimmunity with HCV infection is unclear, various evidences are accumulating.

### Abnormality of Lymphocytic Cells

Another potential cause of autoimmunity is HCV infection in immunocytes. HCV infection in lymphocytes and HCV proliferation within lymphocytes have been demonstrated *in vitro*, and functional alteration of lymphocyte is possibly induced. Production of excessive autoantibodies and cryoglobulin can be induced by abnormal lymphocytic function caused by HCV infection in immunocytes.

Infection of HCV in lymphocytes may cause other extrahepatic manifestations. Abdominal ultrasonography of a patient with chronic hepatitis C often shows swelling of lymph nodes near the hepato-duodenal ligament.<sup>9)</sup> An Italian study reported that approximately 60–70%

of patients with swelling of lymph nodes were HCV-positive. The study concluded that HCV infection induced lymphocyte proliferation.

Furthermore, it has long been suspected that HCV infection is a causative factor in B cell-type non-Hodgkin's lymphoma;<sup>10)</sup> 20–30% of patients with this type of lymphoma are HCV-positive, and their rate is significantly higher than that in volunteer blood donors. However, because HCV RNA has been detected in not all lymphoma cells, the role of HCV in the development of lymphoma is not definitive. Some researchers postulate that proliferation of lymphocytes is caused by abnormal production of cytokines after viral infection.<sup>11)</sup>

### HCV Infection of Cells Other Than Hepatocytes

There are other groups of extrahepatic manifestations caused by infection of HCV into certain kinds of cells. The cause of idiopathic thrombocytopenic purpura (ITP) is considered to be an autoimmune response against plate-



lets, while it may be a result of platelet damage triggered by direct HCV infection into platelets.<sup>12)</sup> However, reports in the first half of 1990s were based on the results showing that separated platelets were found to be HCV RNA-positive by PCR analysis. It is possible that HCV adhering to the platelets was detected in just those studies, because the results cannot be duplicated. A large proportion of researchers consider the cause to be autoimmunity induced by HCV infection.

Similarly, some recent reports have proposed that myocarditis, in particular dilated cardiomyopathy and hypertrophic cardiomyopathy is caused by infection of HCV into myocytes.<sup>13)</sup> The reports showed existence of the minus-strand HCV RNA, indicating the proliferation of HCV in myocytes. However, because the frequency of myocarditis in chronic hepatitis patients reported by hepatologists seems low, its classification as an extra-hepatic manifestation remains unclarified, and some researchers have suggested that there is a virus subgroup with a high affinity for myocytes. The influence of cytokine production by the chronic viral infection in cardiac muscle rather than the direct effects of viral infection is postulated to be the main mechanism involved.

### Intraoral Manifestations

The relationship of cancer in the oral cavity and oral lichen planus with HCV infection has recently been discussed.<sup>14)</sup> It is reported that the HCV antibody-positive rate among patients with cancer in the oral cavity is as high as 25%, and is considered to be due to the continuous excretion of HCV through saliva and blood.

Oral lichen planus is an inflammatory manifestation with abnormal keratinization, and is sometimes confused with stomatitis. There are reports that approximately 60% of patients with this disease are HCV antibody-positive. However, even if the virus is eradicated by interferon treatment the condition persists. Therefore rather than direct viral infestation,

an immunomechanism is considered to play a leading role in the manifestation of the disease.

A recent case report stated that oral lichen planus developed after interferon treatment against hepatitis C. Since half of treated patients presented with the disease after the eradication of HCV with interferon therapy, the author concluded that oral lichen planus was caused by the interferon therapy and not by viral infection.<sup>15)</sup>

### Other Extrahepatic Manifestations

In addition to the aforementioned diseases, porphyria cutanea tarda<sup>16)</sup> and interstitial pneumonia<sup>17)</sup> are reported as potential extra-hepatic manifestations. Porphyria is caused by lowered activity of hepatic uroporphyrinogen decarboxylase. The mechanism of HCV attack on this enzyme has not been totally clarified. For interstitial pneumonia, the involvement of fibrosis in the lung, that is the similar condition observed in the liver of chronic hepatitis, is suspected. The facts are still unclear since this hypothesis is based only on a small epidemiological study.

### Conclusion

Various extrahepatic manifestations of hepatitis C have been reported as described in this paper. However, the direct relationship between HCV and the onset has not been clarified in most cases. For cryoglobulinemia, accompanying nephritis, sialadenitis observed in animal model, and Sjögren's syndrome, the causal relationship with HCV infection is almost certain. For other diseases, however, the discussion starts from the epidemiological reference point that the HCV antibody-positive rate of the patients was higher than that of control groups. Further well designed, comprehensive studies are required from a broad range of aspects. However, based on a review using the key words "vascular manifestations," "HCV infection in cells other than hepatocytes,"

“immuno-transition towards autoimmunity,” and “cytokine,” most of the extrahepatic manifestations seem to present under a similar mechanism, suggesting a relation with HCV. Therefore, successful investigations can be anticipated.

Until now, emphasis for gathering information has been focused on specialists because of the hierarchy of medical practice, but now the participation of general physicians is definitely required. It is recognized that, in dealing with extrahepatic symptoms and manifestation, the careful treatment and diagnosis of patients with a wide range of backgrounds in daily medical practice can yield a vast amount of valuable epidemiological data.

#### REFERENCES

- 1) Agnello, V., Chung, R.T. and Kaplan, L.M.: A role for hepatitis C virus infection in type II cryoglobulinemia. *N Engl J Med* 1994; 73: 53–67.
- 2) Newman, M.G. and Friedman, L.S.: Hepatitis C virus and cryoglobulinemia: Unthawing the association. *Gastroenterology* 1992; 103: 1108–1110.
- 3) Manns, M.P. and Obermayer-Straub, P.: Viral induction of autoimmunity: mechanisms and examples in hepatology. *J Viral Hepat* 1997; 4(Suppl 2): 42–47.
- 4) Alvarez, F., Berg, P.A., Bianchi, F.B. *et al.*: International autoimmune hepatitis group report: review of criteria for diagnosis of autoimmune hepatitis. *J Hepatol* 1999; 31: 929–938.
- 5) Lunel, F. and Cacoub, P.: Treatment of autoimmune and extrahepatic manifestations of hepatitis C virus infection. *J Hepatol* 1999; 31(Suppl 1): 210–216.
- 6) Ganne-Carrie, N., Medini, A., Coderc, E. *et al.*: Latent autoimmune thyroiditis in untreated patients with HCV chronic hepatitis: a case-control study. *J Autoimmun* 2000; 14: 189–193.
- 7) Horsmans, Y. and Geubel, A.P.: Symptomatic myopathy in hepatitis C infection without interferon therapy. *Lancet* 1995; 345: 1236.
- 8) Koike, K., Moriya, K., Yotsuyanagi, H. *et al.*: Sialadenitis resembling Sjögren’s syndrome in hepatitis C virus envelope gene transgenic mice. *Proc Natl Acad Sci USA* 1997; 94: 233–236.
- 9) Ishii, H. and Saito, H.: Perihepatic lymphadenopathy in chronic liver diseases. *J Gastroenterol Hepatol* 2000; 15: 695–696.
- 10) Kagawa, T., Saito, H., Tada, S. *et al.*: Is hepatitis C virus cytopathic? *Lancet* 1993; 341: 316–317.
- 11) Izumi, T.: HCV infection and malignant lymphoma. *Liver, Cholecystis, and Pancreas* 1997; 35: 27–33. (in Japanese)
- 12) Silva, M., Li, X., Cheinquer, H. *et al.*: HCV associated idiopathic thrombocytopenic purpura (ITP). *Gastroenterology* 1992; 102: A 889.
- 13) Matsumori, A.: HCV and myocarditis. Tamakuma, M. and Ishii, H. eds. *Supplement “Igaku-no-ayumi”, Gastrointestinal Diseases, State of Arts, Ver 2*, Ishiyaku-Shuppan, Tokyo, 1999; pp.106–107. (in Japanese)
- 14) Nagao, Y., Sada, M. and Kameyama, T.: Cancer of the oral cavity and oral lichen planus. Tamakuma, M. and Ishii, H. eds. *Supplement “Igaku-no-ayumi”, Gastrointestinal Diseases, State of Arts, Ver 2*, Ishiyaku-Shuppan, Tokyo, 1999; pp.108–111. (in Japanese)
- 15) Sugiyama, T., Shimizu, M., Onishi, H. *et al.*: Clinical review on the relationship between oral lichen planus in chronic hepatitis C and interferon treatment. *Journal of the Japanese Society of Gastroenterology* 2000; 97: 568–574. (in Japanese)
- 16) English JC 3rd, Peake, M.F. and Becker, L.E.: Hepatitis C and porphyria cutanea tarda. *Cutis* 1996; 57: 404–408.
- 17) Ueda, T. *et al.*: Idiopathic pulmonary fibrosis and high prevalence of serum antibodies to hepatitis C virus. *Am Rev Respir Dis* 1992; 146: 266–268.

# When a Child Shows Signs of Retardation in Development

## —When a question arises about a child's development—

JMAJ 45(12): 532–537, 2002

Shunsuke NUMAGUCHI

*Chief Pediatrician, Numaguchi Clinic*

**Abstract:** Questions about development of children are often asked in clinical scene, and one encounters a disease in which development shows gradual regressive degeneration. The percentage of children receiving measles vaccine is not so high in Japan as in western countries and effective prevention of measles still remains a problem. This paper discusses the clinical courses of subacute sclerosing panencephalitis (SSPE), a disease related to measles, and multiple sulfatase deficiency (MSD), an example of inherited metabolic disease, and how to offer counseling and establish diagnosis for “children showing signs of retardation in development.”

**Key words:** Regressive degeneration;  
Subacute sclerosing panencephalitis (SSPE);  
Inherited metabolic diseases; Multiple sulfatase deficiency (MSD)

### Introduction

Clinicians in pediatrics are engaged in preventive health activities such as vaccinations and health screening for infants and children in addition to treating patients. Check-up aims at prevention and early detection of diseases and maintenance and promotion of health, and has been instrumental in early detection of cere-

bral palsy, retardation in psychomotor development, autism, strabismus, hearing impairment, and hydrocephalus. In clinical setting, a pediatrician is in a position to give consultation about children whose development is gradually showing signs of retardation although they have no apparent episodes of encephalitis or encephalopathy. If their growth in body-weight and height is normal and environmental

---

This article is a revised English version of a paper originally published in the *Journal of the Japan Medical Association* (Vol. 126, No. 2, 2001, pages 241–245). The Japanese text is a transcript of a lecture originally aired on February 8, 2001, by the Nihon Shortwave Broadcasting Co., Ltd., in its regular program “Special Course in Medicine”.

factors such as malnutrition or child abuse are not present, what possible causes should one consider?

This article discusses from the standpoint of clinical pediatric diseases showing gradual regressive degeneration as retardation in development, particularly subacute sclerosing panencephalitis (SSPE) related to measles infection that still presents problems in clinical pediatrics, and multiple sulfatase deficiency (MSD), an example of inherited metabolic disease seen by the author, and lastly how a pediatrician should answer the question concerning "apparent retardation in development."

## **Subacute Sclerosing Panencephalitis (SSPE)**

### **1. General trend**

Development of SSPE involves measles virus, as first described by Dowson in 1934. Subsequently, Van Bogaert named it as "subacute sclerosing leukoencephalitis." The disease had been considered intractable until 1967 when a high measles antibody titer was discovered in serum and CSF, and the disease was re-named as subacute sclerosing panencephalitis (SSPE) at an international congress. In 1969, measles-like virus was isolated.

The age of onset is between 5 and 15, the disease is more prevalent in boys, and the incidence is 1.4–1.8 in about one million. An epidemiological survey in the U.S. reported that measles vaccination decreased the incidence of SSP, and that it is higher among those who became infected by measles naturally. In Japan, however, despite the regulation vaccination of measles, the prevalence of receiving vaccination is as low as 70%, measles epidemic is controlled only mildly, and epidemics are observed in limited areas.

The Japan Pediatric Association has produced a poster advocating "Measles vaccination for one year olds," and started the movement to eradicate the epidemic. Regrettably, the risk of developing SSPE remains high in Japan,

despite being a highly developed country.

### **2. Clinical signs**

The onset is after an asymptomatic period of 6 to 8 years following measles infection. The initial period of SSPE is characterized by (1) high brain function disorders such as change in personality, and (2) focal or generalized seizures (myoclonic jerks).

When I was studying clinical neurology in children at St. Vincent de Paul Pediatric Hospital in Paris, I encountered an SSPE patient. The child appeared normal with adequate language skills, but when a doctor asked the child to draw the upper half of a house and add it to the lower half of the house drawn on the blackboard, the child could not draw the roof even though the child understood words such as blackboard and chalk. The child also did not know how to use a ballpoint pen. I was told that the child began to have difficulties at school 5 to 6 years after being infected with measles and to show marked retardation in psychomotor development.

Clinical neurological signs include high brain dysfunctions in orientation, short memory, judgment, calculation, and linguistic expression and understanding. Seizures are usually instantaneous myoclonic jerks. At the time when seizures (myoclonic jerk) appear for the first time, they are not accompanied by disturbance of consciousness and they are deemed not as seizure but as awkwardness or susceptibility for stumbling. As the disease progresses, extrapyramidal tract signs such as athetosis and spastic pyramidal tract signs become more apparent, leading to hypertonia and decerebrate rigidity, culminating in death in 1 to 3 years.

### **3. Morbidity types**

There are several morbidity classifications of SSPE; Jabbour classifies it into four; (1) stage I of cerebral signs such as indifference and withdrawal, (2) stage II of spasms and motor signs such as myoclonic seizure, (3) stage III of comas not reacting to any types of stimulus and

opisthotonus, and (4) stage IV of mutism and loss of cerebral functions such as pathological laughter and freight reaction to sounds, and myoclonus.

A patient, who is examined in the second stage of spasms, found with suppression burst by EEG and elevation of measles antibody titer in serum and CSF, may be diagnosed as SSPE. However, if the patient is examined in the first stage in outpatient clinic by complaining changes in personality, the physician is likely to overlook the disease. It is therefore recommended to take history of natural infection of measles and measles vaccination, to attempt clinical diagnosis of disorder of high brain function if there is even a slight suspicion of SSPE, and to perform less invasive EEG examination. This is because of a report that characteristic suppression bursts appeared at four years prior to development of myoclonic spasms.

### **Inherited Metabolic Disease**

A case of multiple sulfatase deficiency (MSD), an inherited metabolic disease, is discussed.

The patient was an 8-year-old boy admitted to an institution for children with severe psychosomatic disorders. He was born at 40 weeks with the bodyweight of 2,110g, his parents were not blood relations, and his sister was healthy. The mother experienced no problems in pregnancy or delivery, but he was somewhat retarded in development as his neck stood at 4 months, he could sit at 7 months and walk by holding onto a support at 11 months. Although he was examined by a doctor because of failure to walk at the same time as other children, he was placed on observation because of retardation in motor development.

He started to walk at 21 months and even went swimming with the family. After 24 months, he began to manifest fixed ocular movement, tonic spasm, and his retardation became pronounced. When he was 3 years old, he could manage to stand, but he could no

longer walk and his reactions to stimulus became dull. Although he was referred to a university hospital, no diagnosis was rendered. He became immobilized below his neck and bed-ridden when he was about 4. Articular contracture was observed in his upper and lower limbs and he was being cared for at home until admission to a nursing home by mediation of a health center.

He lost spontaneous speech, articular contracture of the limbs was pronounced, and his pathological reflex like Babinski's reflex became severe beyond recognition. However, promoted clonus and bilateral patellar tendon reflex were evident. He manifested ichthyosis, slight saddle nose, thickened eyebrows and eyelashes, and barrel-shaped thoracics. EEG findings generally included slow waves, poorly developed alpha waves, and peripheral nerve conduction velocity was slowed to 30.3 m/sec when measured at the median nerve.

Inherited metabolic disease was suspected, and mucopolysaccharide in urine was analyzed. Total uronic acid was about 3 to 4 times more than the control and increased excretions of heparan sulfate and chondroitin sulfate A and C were observed in mucopolysaccharide electrophoresis. A significant increase of sulfatide was observed in the analysis of glycolipid in urine. Measurement of active leukocyte arylsulfatases A, B, and C revealed lowered values in all, leading to the diagnosis of MSD, a subtype of metachromatic leukodystrophy (MLD), inherited metabolic disease.

The patient began to manifest symptoms gradually from the time when he was one year old, but it took visits to various clinics and university hospitals until for seven years, before the diagnosis was established.

With remarkable progress in medicine in the 21st century, it is now possible to render gene diagnosis and treatment. While time consumed for diagnosing inherited metabolic diseases was undeniably extended, it may have been unavoidable because of the delay in establishing diagnostic techniques. Still, there remains a

problem of how to address the question regarding "retardation in development" in the clinical setting.

## Diagnosis

### 1. Approach

In the pediatric outpatient clinic, the question is how to approach "children who are showing signs of retarded development" with regressive degeneration. It is necessary to first analyze the growth curves in height and bodyweight, and try to detect problems in nutrition or child abuse, if any. I have encountered many teen-age parents in Japan recently with infants with iron deficiency anemia and Hb count of 2–3g/l as well as psychomotor development delays because the parents feed the baby only fast foods and confections, and babies repeatedly contract infections and iron deficiency anemia because the mother does not change diapers nor consider its nutrition as she leaves childcare totally to the grandmother. We should be aware of the fact that modern Japan is faced with nutrition problems in the environment that are entirely different from hypnutrition of post-second world war years.

As regards the family history and neurological findings, it is difficult to define the pathological areas such as the pyramidal tract, extrapyramidal tract, and cerebellar symptoms of adults because children's central nervous system is still immature and in the process of growth. When examining a child, one should evaluate postural reflexes such as Landau reflex, Collis horizontal reflex, axillary suspension reflex, Vojta reflex, and traction reflex in addition to evaluation of primitive reflexes such as stepping reflex, extension reflex, and Moro's reflex. According to Sainte-Anne Dargassie, the key ages in development are three months, eight months, and ten months after birth.

The characteristics of children with regressive degeneration are family's impression that the child shows "notable retardation in development" and "it began to show apparent retar-

ation in development without clear episodes after achieving certain degree of development." Thus, evaluation of development as well as observation of the progress is important. As shown by the author's experience of MSD, one should fully understand the findings regarding child's development, family history, and abnormal neurological signs. Otherwise, the child will be left unattended as no diagnosis is established in the clinical medicine, and will be left to handling by the administration.

### 2. Laboratory tests

Laboratory tests include those of CT, EEG, MRI, CFS, peripheral nerve conduction velocity, fundas, blood chemistry, urine, etc. These values often fall within the normal range, and the important thing is what to suspect from the age of onset. Then, the tests should be selected from those on chromosomes, biopsy of peripheral nerves and muscles, analyses of urine glucose and lipid and urine mucopolysaccharides, leukocyte enzymes, and tests of genes.

### 3. Differential diagnosis

The incidence of disease groups showing regressive degeneration is clearly low compared to cerebral palsy. However, in clinical pediatrics where measles are not eradicated because about 70% of subjects receive vaccinations, the presence of SSPE, typical subacute or chronic progressive encephalitis, should be suspected in subjects ranging from infancy to lower school age children.

In differential diagnosis, progressive rubella panencephalitis should be noted. Symptoms of this disease appear after 4 to 14 years since infection with rubella as in the case of SSPE, and the patient gradually develops dementia, followed by pyramidal and extra-pyramidal symptoms, and finally by death. In diagnosis, these clinical symptoms, high amplitude slow waves in EEG (without periodic character as in SSPE), and elevation of rubella antibody titer in serum and CSF are useful.

Another disease to be differentiated is pro-

gressive encephalitis by metabolic disease. The diagnostic classification by the age of onset published in a reference is quite useful. The classification divided into 6 groups of A) neonatal period, B) infancy, C) early childhood, D) late childhood, E) adolescence, and F) adult life.

Twelve inherited metabolic diseases observed in late childhood, the period similar to the onset age of SSPE, include

- (1) milder disorders of amino acid metabolism
- (2) metachromatic leukodystrophy
- (3) mucopolysaccharidoses
- (4) Bielshowsky-Jansky "ceroid" lipofuscinosis.

The author estimated that the onset for MSD occurred in infancy, but it was a sub-type of metachromatic leukodystrophy (MLD), or Austin's disease. The author reported the first case in Japan at the time when there were only ten-odd cases in the world.

Clinical characteristics of the disease were progressive dementia and kinetic disorders. Exaggerated tendon reflexes were followed by its decrease or disappearance as the peripheral nerves are damaged with the progress in disease. The patient manifested severe acrocontracture and decreased peripheral nerve conduction velocity although decline or disappearance of tendon reflexes could not be proven. Clinical neurological findings showed co-presence of paralysis due to disease of the upper & lower motor neuron. As seizure was not so pronounced during the extensive clinical course in the patient, the author suspected extensive lesions of cerebral white matter rather than gray matter. As this is an autosomal recessive disease, the activity of lysosomal enzyme in leukocyte was done in parents and sibling (elder sister). The parents were heterozygous status and showed clear signs of lowered enzyme activities, but the sibling was within the normal range.

#### 4. Others

Gene studies will advance and enable confirming diagnosis of various diseases in this

century, and the time will come when prevention and treatment of intractable diseases showing regressive degeneration and inherited metabolic diseases are possible as in the case of phenylketonuria (PKU) and some of Gaucher's disease. As at the time CT and MRI were first introduced in the 1970s and 1980s, clinical pediatricians are recommended to examine, first of all, the growth curve carefully when "growth retardation is notable" and fully study the changes in high cerebral functions, to determine the policy for necessary tests, and to continue observation of the course even if diagnosis at that time point is impossible.

As European countries such as UK, France, and Germany are faced with the major problem of mad cow's disease as it spreads beyond the national borders, we must be prepared to challenge diseases that are relevant with our dietary life. Clinical pediatricians should listen to the family's complaints of "something is wrong" or "growth delay is becoming apparent," analyze and observe the courses.

#### Conclusion

According to WHO, the Japanese system of public health ranks the 1st in the world in overall evaluation for "maintaining life," but it ranks the 10th in "efficiency". In this century, it will be critical to establish a maternal health system in the community medicine by working together with university hospitals, observing the course, and feeding information back to families in case of patients for whom the diagnosis cannot be established immediately.

Because of the limited space, I could not discuss the details of Wilson's disease, degenerative diseases, and inherited metabolic diseases, but I would appreciate it very much if the readers would understand how the general pediatric outpatient clinic works through my experiences.

**REFERENCES**

- 1) Numaguchi, S., Takahashi, K., Handa, T. and Eto, Y.: *J Pediatric Practice* 1979; 42(2): 141–146. (in Japanese)
- 2) Oya, T., Tamura, Y. and Shimoda, K.: *Learning through Case Reports. Neurological Diseases in Infants*. Chugai Igakusha, 1986. (in Japanese)
- 3) Morooka, K. and Arimoto, K. (translation into Japanese): *Developments in Infants. Normal and Borderline Cases*. Bunkodo, 1998. (in Japanese)
- 4) Eto, Y.: Multiple Sulfatase Deficiency (Mucosulfatidosis). *European Journal of Pediatrics* 1980; 135: 85–89.
- 5) Menkes, J.H.: *Menkes Textbook of Child Neurology*. Lea & Febiger, Philadelphia.
- 6) Adams, R.D. and Victor, M.: *Adams and Victor's Principles of Neurology*. McGraw-Hill Book Co., New York.



# Neuroimaging for Diagnosis of Psychiatric Disorders

JMAJ 45(12): 538–544, 2002

Yoshio HIRAYASU

*Associate Professor, Department of Neuropsychiatry  
Kyorin University School of Medicine*

**Abstract:** Recent advances in computer technology have allowed detailed investigation of brain structures. While psychiatric disorders have been diagnosed on the basis of clinical symptomatology, the results are relatively ambiguous compared to the diagnostic procedures for physical disorders, since no objective methods of examination have been available on which to base the diagnosis. Recent studies have shown that quantitative and qualitative evaluation of MRI images has allowed us to find structural brain abnormalities in various brain regions, including the lateral ventricles, temporal lobe, and frontal lobe, to be identified in schizophrenia, and the abnormalities have been demonstrated in first episode as well as in chronic patients. Progressive volume reduction has also been reported in the lateral ventricles and superior temporal gyrus in follow-up studies. In addition structural abnormalities have been revealed in hippocampus and anterior cingulate cortex of patients with affective disorders. The concept of classical functional psychoses, such as schizophrenia and affective disorders, may change in the near future.

**Key words:** Schizophrenia; Affective disorder; Neuroimaging; MRI

## Introduction

The diagnosis of psychiatric disorders, e.g., schizophrenia, affective disorders, and anxiety disorders, has generally been based on patients' mental and/or psychological state as determined by clinical interviews with patients and their families, but this diagnostic process is more ambiguous than for physical diseases that are confirmed by blood tests and/or imaging

tests. The implications of psychiatric disorders might change if tools were available to diagnose them more objectively.

Recently, technological advances have improved neuroimaging techniques so that they now allow analysis of the structure and function of the human brain. These techniques have played important roles in understanding the pathology of psychiatric disorders and include MRI (magnetic resonance imaging) and CT

---

This article is a revised English version of a paper originally published in the *Journal of the Japan Medical Association* (Vol. 126, No. 3, 2001, pages 403–408). The Japanese text is a transcript of a lecture originally aired on February 21, 2001, by the Nihon Shortwave Broadcasting Co., Ltd., in its regular program "Special Course in Medicine".

(computed tomography), which enable observation of the structure and morphology of the brain, and PET (positron emission tomography) and SPECT (single photon emission computed tomography), which enable visualization of brain function.

Although PET has become more common as a result of recent advances in technology, it is still invasive and costly for general clinical assessments because of the need for radioactive material. More recently, a new MRI method, functional MRI, has been developed to measure blood flow, which is a reflection of neuronal activation of the brain. Functional MRI is also expected to serve as a new clinical tool, because it is noninvasive and can be performed with a standard MR system, although additional studies are required due to the complex imaging analyses. Electroencephalography (EEG) has often been used to evaluate brain function in epilepsy, encephalitis, cerebrovascular disorders, and brain injury, but no specific EEG abnormalities have been identified in psychiatric disorders, including schizophrenia and affective disorder.

MRI and CT have contributed to the diagnosis of psychiatric disorders associated with organic brain lesions, i.e., neurodegenerative disorders including Alzheimer's disease, multiple infarctions, encephalitis, and brain injury. However, MRI or CT cannot be applied to the diagnosis of schizophrenia or affective disorders, which are so-called endogenous psychoses, although it might be possible to use the images as a new diagnostic tool in the near future. This paper reviews recent findings in regard to structural abnormalities in schizophrenia and affective disorders, and brain imaging perspectives are also discussed.

## **Abnormalities Revealed by Structural Brain Imaging in Schizophrenia**

### **1. Qualitative imaging studies**

Schizophrenia is a chronic brain disorder with a 1% prevalence in the population. Its onset occurs in adolescence, and it is very costly

to society economically. Recent studies have shown that qualitative evaluation of MRI images allows identification of structural brain abnormalities of certain degrees in schizophrenia. Mild or more severe cortical brain atrophy has been found in 57% of schizophrenia patients by MRI, and the odds of cortical atrophy were 11.7 times higher in patients with schizophrenia compared to normal subjects of the same age. Schizophrenic patients who did not respond to treatment had a 2.8 times higher incidence of cortical atrophy compared to those who responded, and cortical atrophy or ventricle enlargement was detected in 40–60% of patients with schizophrenia as opposed to 5% of normal subjects. These findings suggest that brain abnormalities can be identified by qualitative analysis, although continuous, thin (at thickest 3 mm) MR slices are required to assess structural change in the brain qualitatively.

### **2. Quantitative Imaging Studies**

This section summarizes the results of quantitative analyses of MRI and CT data. Enlargement of the lateral ventricles and reduction of temporal and frontal lobes have often been reported in schizophrenia. Brain structure has been noninvasively investigated since CT was invented 30 years ago, and the first CT study to demonstrate ventricle enlargement in patients with schizophrenia was reported in 1976. MR acquisition techniques have subsequently advanced to the point where detailed spatial resolution, up to 1 mm, is now possible.

#### **(1) Lateral ventricles**

Lateral ventricle enlargement has been reported in 70% of the studies on schizophrenia conducted over the past ten years.<sup>1)</sup> Although enlargement of the lateral ventricles is not specific to schizophrenia, this suggests that structural abnormalities are based on neurodevelopmental disturbances in schizophrenia, since ventricular abnormalities have been found in other brain disorders with neurodevelopmental deficits. However, the ventricle enlargement may have resulted from brain atrophy of

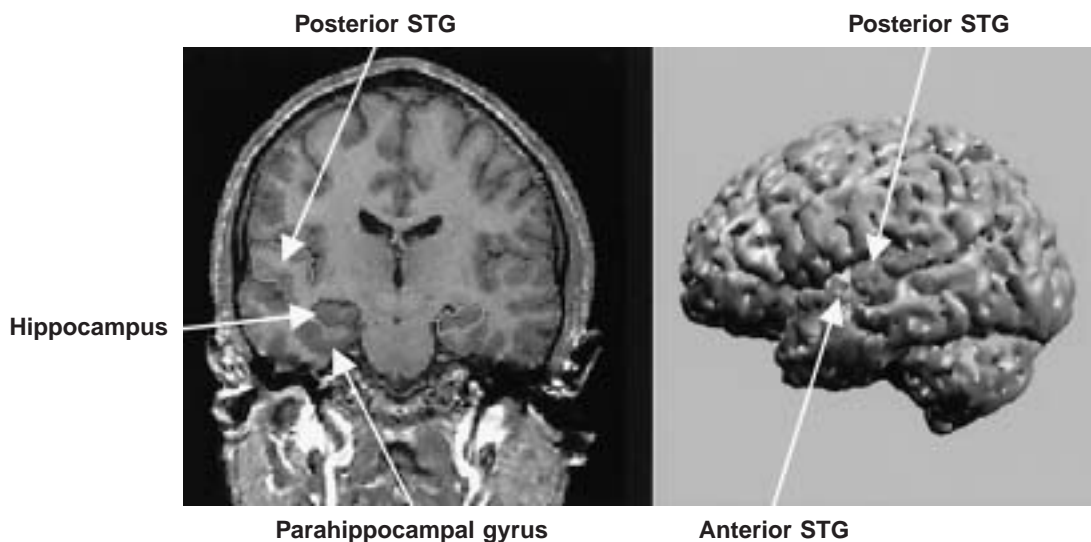

(From Hirayasu, Y. *et al.*: *Am J Psychiatry*, 1998, modified)

Fig. 1 Left: Coronal MRI of a normal subject  
Right: 3D reconstruction image of superior temporal gyrus

the gray matter and white matter. Clinically, the enlargement of the lateral ventricles was closely correlated with duration of illness and poor outcome.<sup>2)</sup>

## (2) Temporal lobe

MRI has enabled identification of the boundary between the gray and white matter, which was never clearly seen on CT images. This advantage of MRI yielded more information on structural changes in the brain. The gray matter consists of several layers of neurons, while the white matter consists of bundles of their fibers, making it important to measure the two structures separately, because they have different functions.

Changes in the temporal and frontal lobes have been extensively reported in schizophrenia, although total cortical volume reduction has also been reported. The temporal lobe plays a role in processing auditory information from the ears, and the temporal lobe in the dominant hemisphere plays a central role in language in humans. Manifestations of hallucinations and delusions are assumed to be associated with language function, and for these reasons, a temporal lobe abnormality has been

suspected in schizophrenia.

Decreases in volume were found in 60% of studies that measured the whole temporal lobe in schizophrenia,<sup>1)</sup> and marked gray matter volume reduction has been found in the superior temporal gyrus (STG, Fig. 1). The surface of the STG is anatomically divided into two structures: Heschl's gyrus and the planum temporale (PT). Heschl's gyrus plays a role in primary/secondary auditory information processing, while the PT is associated with language function in the dominant hemisphere. The severity of clinical assessment scores for hallucinations has been found to be associated with volume reduction of the STG.<sup>4)</sup> An abnormality of the posterior STG was also found to be significantly correlated with scores for disorganized thought in patients with schizophrenia.<sup>5)</sup>

Deficits or reversals of normal asymmetry have also been reported in left and right brain structures in schizophrenia. As an example, the PT in the STG is larger in the dominant hemisphere (left > right for normal right-handed person) than on the other side (Fig. 2), but recent studies have suggested loss or even reversal (left < right) of the asymmetry of the PT

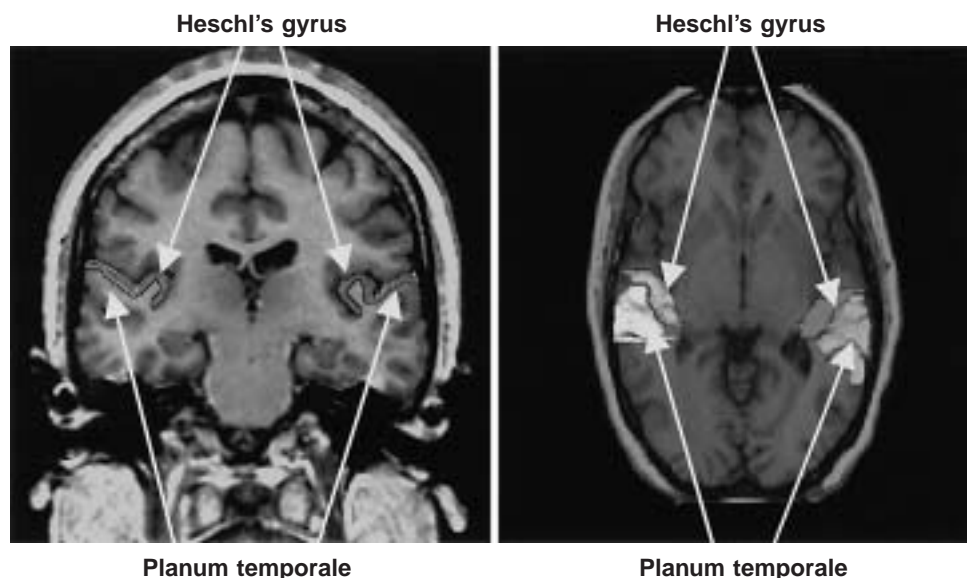

(From Hirayasu, Y. et al.: *Arch Gen Psychiatry*, 2000, modified)

Fig. 2 Left: Coronal MRI of a normal subject  
Right: 3D reconstruction image of Heschl's gyrus and planum temporale on an axial MRI image

in patients with schizophrenia.<sup>6)</sup> Since the PT is believed to develop in the early stages of fetal life, neurodevelopmental abnormalities in the fetal stage are responsible for the lack of normal asymmetry in the region in schizophrenia.

The amygdala and hippocampus contribute to functions of emotion and memory, respectively. Morphometric change has been extensively investigated in these medial temporal structures in schizophrenia. Volume reduction of the hippocampus has been reported in 70% of studies that measured this region in schizophrenia.<sup>1)</sup>

### (3) Frontal lobe

The frontal lobe plays an important role in higher cognitive function in humans. Although functional brain imaging studies by PET and SPECT have revealed frontal abnormalities in schizophrenia, the results for structural abnormalities have been inconsistent compared to the temporal lobe. Postmortem studies have suggested a gray matter volume reduction of about 8% in schizophrenia, which is slightly below the threshold of statistical significance.

Parcellation studies of frontal lobe are important, since individual lobes in the frontal area have different functions. The prefrontal lobe is the critical site for working memory (Fig. 3), and correlation studies with clinical symptoms have suggested that volume reduction in the prefrontal cortex is associated with negative symptoms, i.e., affective flattening, alogia, or avolition.

### (4) Structural brain abnormalities in first episode patients

It remained unclear when the structural abnormalities occur in relation to and the onset of symptoms, whether the abnormalities change over time or change after treatment. Many MRI studies have been carried out, mostly in chronic schizophrenia, because the patients are relatively easy to recruit and are maintained in a stable psychiatric state. However, the abnormalities in the chronic patients may be influenced by long-term medication with neuroleptics and anticholinergic drugs, institutionalization, and the patients' unique life style, making it important to investigate first episode patients

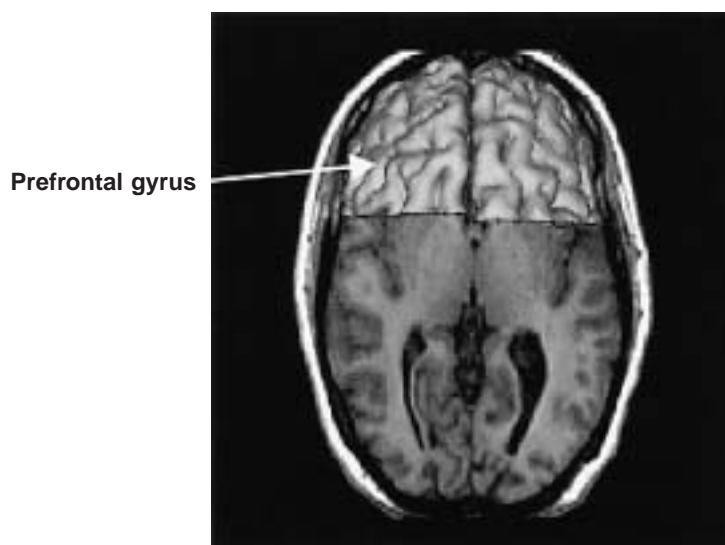

(From Hirayasu, Y. *et al.*: *Cereb Cortex*, 2001, modified)

Fig. 3 3D reconstruction image of prefrontal cortex on an axial MRI from a normal subject

to clarify the above issues.

Recent studies have revealed that the gray matter volume of the left posterior STG is significantly reduced in the first episode schizophrenia compared to age-matched normal controls and patients with affective disorder, and left hippocampal volume has also been found to be smaller in the first episode of schizophrenia compared to normal controls, but not in affective disorder.<sup>8,9)</sup> The results of the search for abnormalities in first episode studies have been inconsistent in the prefrontal lobe, compared to the temporal lobe. Our recent findings have suggested bilateral volume reduction in the prefrontal gray matter in the first episode of schizophrenia relative to normal controls and affective disorders.<sup>10)</sup>

#### **(5) Structural changes in follow-up studies**

One of the possible advantages of first episode studies that they allow is follow up to detect possible changes over time and the effect of treatment on structural abnormalities. Although small numbers of follow-up studies have been reported, our preliminary investigation suggested that 90% of patients with

schizophrenia showed 11% gray matter volume reduction in the left STG when MR measurements were made 1.5 years apart.<sup>11)</sup> These findings suggested that the structural abnormalities in the chronic stage may be present in the early stage of the illness and progressively change in some regions over time, although the effect of medication cannot be ruled out, since most of the subjects were treated with neuroleptics even in the first episode stage. In addition, progressive enlargement has also been reported in the lateral ventricles in schizophrenia.<sup>12)</sup> Although it is important to check changes of progressive enlargement, follow-up studies are extremely difficult to complete in a single institution. Rapid technological advances also impede follow-up studies because of the inequality of acquisition images between recordings.

#### **Abnormalities Detected by Structural Brain Imaging in Affective Disorders**

Affective disorders are generally classified into bipolar disorder, with cycles of depressive

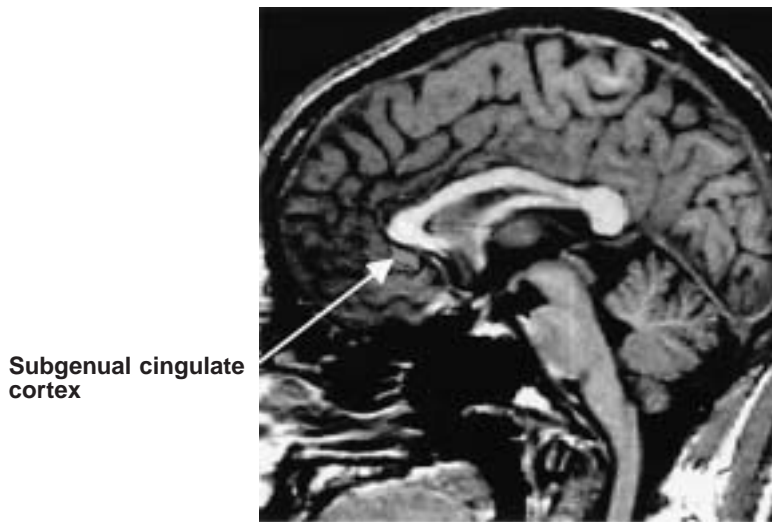

Fig. 4 3D reconstruction image of the anterior subgenual cingulate gyrus on a sagittal MRI image from a normal subject

and manic states, and major depression alone, with a depressive state. The prevalence of major depression has increased (3–5%) in many countries. Significant volume reduction in the hippocampus and anterior subgenual cingulate cortex and high intensity of the white matter have been reported in affective disorders although the evidence of structural abnormalities has not been as great as in schizophrenia (Fig. 4). The cingulate cortex plays an important role in emotion and will, which are associated with depressive symptoms.

PET studies have also revealed hypofunction in the anterior subgenual cingulate cortex in chronic recurrent depression, and volume reduction has been reported in this region in patients with a family history of depression, but not in patients without a family history.<sup>13)</sup> Unlike schizophrenia, however, there have been few reports of volume reduction in the frontal or temporal lobe in affective disorders. This suggests that structural abnormalities of the frontal and temporal cortex might be specific to schizophrenia.

## Conclusion

Recently, technology for processing and storing large amounts of neuroimaging data has greatly advanced, and it may be possible to identify the size of individual brain regions soon after MR acquisition in physicians' offices in the near future. The concept of classical functional psychosis, such as schizophrenia and affective disorders, may change in the near future.

## REFERENCES

- 1) McCarley, R.W., Wible, C.G., Frumin, M., Hirayasu, Y., Levitt, J.J., Fischer, I.A. and Shenton, M.E.: MRI anatomy of schizophrenia. *Biol Psychiatry* 1999; 45(9): 1099–1119.
- 2) Galderisi, S., Vita, A., Rossi, A., Stratta, P., Leonardi, M., Maj, M. and Invernizzi, G.: Qualitative MRI findings in patients with schizophrenia: A controlled study. *Psychiatry Res* 2000; 98(2): 117–126.
- 3) Gur, R.E., Turetsky, B.I., Bilker, W.B. and Gur, R.C.: Reduced gray matter volume in schizophrenia. *Arch Gen Psychiatry* 1999; 56(10):

- 905–911.
- 4) Barta, P.E., Pearlson, G.D., Powers, R.E., Richards, S.S. and Tune, L.E.: Auditory hallucinations and smaller superior temporal gyral volume in schizophrenia. *American Journal of Psychiatry* 1990; 147(11): 1457–1462.
  - 5) Shenton, M.E., Kikinis, R., Jolesz, F.A., Pollak, S.D., LeMay, M., Wible, C.G., Hokama, H., Martin, J., Metcalf, D., Coleman, M. and McCarley, R.W.: Abnormalities of the left temporal lobe and thought disorder in schizophrenia: A quantitative magnetic resonance imaging study. *New England Journal of Medicine* 1992; 327(9): 604–612.
  - 6) Kwon, J-S., McCarley, R.W., Hirayasu, Y., Anderson, J.E., Fischer, I.A., Kikinis, R., Jolesz, F.A. and Shenton, M.E.: Left planum temporale volume reduction in schizophrenia. *Arch Gen Psychiatry* 1999; 56: 142–148.
  - 7) Selemon, L.D., Rajkowska, G. and Goldman-Rakic, P.S.: Elevated neuronal density in prefrontal area 46 in brains from schizophrenic patients: Application of a three-dimensional stereologic counting method. *J Comp Neurol* 1998; 392: 402–412.
  - 8) Hirayasu, Y., Shenton, M.E., Salisbury, D.F., Dickey, C.C., Fischer, I.A., Mazzoni, P., Kisler, T., Arakaki, H., Kwon, J.S., Anderson, J.E., Yurgelun, T., Tohen, M. and McCarley, R.W.: Lower left temporal lobe MRI volumes in patients with first-episode schizophrenia compared with psychotic patients with first-episode affective disorder and normal subjects. *Am J Psychiatry* 1998; 155(10): 1384–1391.
  - 9) Hirayasu, Y., McCarley, R.W., Salisbury, D.F., Tanaka, S., Kwon, J.S., Frumin, M., Snyderman, D., Yurgelun Todd, D., Kikinis, R., Jolesz, F.A. and Shenton, M.E.: Planum temporale and Heschl gyrus volume reduction in schizophrenia: A magnetic resonance imaging study of first-episode patients. *Arch Gen Psychiatry* 2000; 57(7): 692–699.
  - 10) Hirayasu, Y., Tanaka, S., Shenton, M.E., Salisbury, D.F., DeSantis, M.A., Levitt, J.J., Wible, C.G., Yurgelun Todd, D., Kikinis, R., Jolesz, F.A. and McCarley, R.W.: Prefrontal gray matter volume reduction in first episode schizophrenia. *Cereb Cortex* 2001; 11: 374–381.
  - 11) Hirayasu, Y., Shenton, M.E., Salisbury, D.F., Fischer, I.A., Kisler, T., Kwon, J-S., Dickey, C.C., Yurgelun-Todd, D.A., Tohen, M. and McCarley, R.W.: Superior temporal gyrus changes over time in first episode schizophrenia. (abstract). *Biol Psychiatry* 1998; 43: 116S.
  - 12) DeLisi, L.E., Sakuma, M., Tew, W., Kushner, M., Hoff, A.L. and Grimson, R.: Schizophrenia as a chronic active brain process: A study of progressive brain structural change subsequent to the onset of schizophrenia. *Psychiatry Res* 1997; 74(3): 129–140.
  - 13) Hirayasu, Y., Shenton, M.E., Salisbury, D.F., Kwon, J.S., Wible, C.G., Fischer, I.A., Yurgelun Todd, D., Zarate, C., Kikinis, R., Jolesz, F.A. and McCarley, R.W.: Subgenual cingulate cortex volume in first-episode psychosis. *Am J Psychiatry* 1999; 156(7): 1091–1093.

---

# Table of Contents of Japan Medical Association Journal Vol. 45, Nos. 1–12, 2002

Pages	No.	Pages	No.
1—44	1	271—316	7
45—90	2	317—360	8
91—134	3	361—406	9
135—180	4	407—452	10
181—226	5	453—498	11
227—270	6	499—550	12

## **Vol. 45, No. 1**

**January, 2002**

### *Visual Disorder*

Guidelines for the Management of Diabetic Retinopathy for the Internist Sadao HORI .....	1
Glaucoma Yasuyuki SUZUKI .....	8
Exudative Age-related Macular Degeneration Mitsuko YUZAWA .....	13

### *Depression*

Clinical Characteristics of Depression Arata SATO and Shin IHDA .....	21
Drug Therapy for Depression in Japan Makoto KAMIMURA and Anri AOBA .....	28

### *Low Birth Society*

Expectations of a Low Birth Society —From the Perspective of Historical Demography— Hiroshi KITO .....	34
---	----

---

## **Vol. 45, No. 2**

**February, 2002**

### *Inflammatory Bowel Disease*

Pathology and Diagnosis of Inflammatory Bowel Disease (IBD) Takashi SHIMOYAMA .....	45
Surgical Treatment of Inflammatory Bowel Disease (IBD) Tetsuichiro MUTO .....	55

Lifestyle Guidance and Diet for Inflammatory Bowel Disease (IBD) Patients Tadao BAMBA .....	63
---	----

### *Vaccination*

Management of Viral Infection during Pregnancy Takashi KAWANA .....	69
---	----



---

Revision of Preventive Vaccination Law and Future Trends	
Hitoshi KAMIYA .....	75

**Recent Topics**

Protein Restriction Diet as an Essential Tool in Treating Uremia: Myth or Truth?	
Yoshitaka MAEDA and Tatsuo SHIKAI .....	80

The 2000 Guidelines for the Treatment of Hypertension	
Takao SARUTA .....	84
Future Outlook for Treatment of Chronic Hepatitis C	
Shiro IINO .....	88

---

**Vol. 45, No. 3**

**March, 2002**

**Patient Safety**

Measures Taken from the Aspect of Nursing Jobs to Prevent Medical Accidents	
Yoshiko SHIMAMORI .....	91

**Clinical Medicine**

Drug Treatment of Toxemia of Pregnancy —Indications and Limitations—	
Yuichiro NAKAI, Junko NISHIO and Sachio OGITA .....	97
Establishing the Concept of Visceral Fat Syndrome and Clarifying Its Molecular Mechanisms	
Yuji MATSUZAWA .....	103

Alcoholic Liver Disease in Women	
Masayoshi YAMAUCHI .....	111

**Cancer**

Present State of Gene Diagnosis and Future Prospects	
Eiichi TAHARA .....	118
Gastric Cancer —Prevention and Early Diagnosis—	
Shigetoyo SAJI and Katsuyuki KUNIEDA .....	125
Liver Cancer —Prevention and Early Diagnosis—	
Michio IMAWARI .....	130

---

**Vol. 45, No. 4**

**April, 2002**

**Acute Myocardial Infarction**

Key Points and Pitfalls in Electrocardiographic Diagnosis of Acute Myocardial Infarction	
Toshihisa ANZAI and Satoshi OGAWA .....	135
Present Status of Pre-hospital Thrombolytic Therapy for Acute Myocardial Infarction —Its Indications and Problems—	
Takeshi MOTOMIYA .....	143
Complications of Acute Myocardial Infarction —Diagnosis and Treatment—	
Hiroshi NONOGI .....	149

Acute Coronary Syndromes	
Hirofumi YASUE .....	155

**Social Security**

Social Security Viewed from a Demographic Perspective: Prospects and Problems	
Naohiro OGAWA .....	161
Agenda for Japanese Social Security	
Yoshinori HIROI .....	168

**Recent Topics**

Adrenal Preclinical Cushing's Syndrome	
Toshihiro SUDA .....	172

---

Characteristics of Multislice CT	
Kazuhiro KATADA .....	175

---

**Vol. 45, No. 5**

**May, 2002**

***JMA Policies***

The Current State of Health Care System Reforms and Future Issues	
Takashi AOYAGI .....	181

***Stress-related Diseases***

Stress and Hypertension	
Shinichi NOZOE and Takao MUNEMOTO .....	187
Ischemic Heart Disease	
Takenori KIKUCHI .....	192
Diabetes Mellitus	
Yuichi YAMAUCHI .....	197
Tension-type Headaches	
Koji TSUBOI .....	202

***Kawasaki Disease***

Current Review of the Etiology of Kawasaki Disease	
Tomisaku KAWASAKI .....	207

***Mental Health***

Pregnancy, Delivery and Mental Health	
Fumi HORIGUCHI and Shiro NOZAWA .....	214

***Public Health***

Health Risk Assessment as Educational Tools for Health Promotion	
Katsumi YOSHIDA .....	222

---

**Vol. 45, No. 6**

**June, 2002**

***JMA Policies***

Basic Policies of the Japan Medical Association	
Eitaka TSUBOI .....	227

***Respiratory Diseases in the Elderly***

Characteristics of Respiratory Diseases in Older People	
Hidetada SASAKI <i>et al.</i> .....	231
Treatment and Management of Elderly Bronchial Asthma	
Noritaka HIGASHI and Kazuo AKIYAMA .....	237

Prophylaxis and Treatment for Influenza among the Elderly	
Hajime GOTO .....	245

Treatment of Community-Acquired Pneumonia in the Elderly	
Toshiharu MATSUSHIMA .....	251

***Breast Cancer***

Current Imaging Diagnosis of the Breast Tumors	
Tokiko ENDO .....	258
Molecular Diagnosis for Breast Cancer	
Takemitsu NAGAHATA <i>et al.</i> .....	265

---

---

**Vol. 45, No. 7**

**July, 2002**

***Oxidative Stress***

- What Is Oxidative Stress?  
Toshikazu YOSHIKAWA and  
Yuji NAITO .....271
- Aging and Oxidative Stress  
Masayuki YOKODE and  
Toru KITA .....277

***Acute Myocardial Infarction***

- Prehospital Management of  
Acute Myocardial Infarction:  
—History Taking, Physical Examinations,  
and Laboratory Procedures—  
Kinji ISHIKAWA .....283
- Diagnostic Approach in the Elderly  
Makoto SAKAI .....288

***Brain Death in Children***

- Report on the Criteria for the Determination  
of Brain Death in Children  
Part I: Survey of Clinical Practices in  
the Diagnosis of Brain Death  
in Children in Japan  
Kazuo TAKEUCHI *et al.* .....291

***Topics***

- Progress in Diagnosis and Treatment  
of Osteoporosis  
Hajime ORIMO .....308
- Health Impact of Dioxins  
Osamu WADA .....312

---

**Vol. 45, No. 8**

**August, 2002**

***JMA Policies***

- Promoting Antismoking Activities  
Hideya SAKURAI .....317

***Antismoking***

- Smoking Prevention Education for  
Adolescents in Japan  
Tetsuro KAWABATA .....324
- Survey of Smoking Behaviors and Attitudes,  
and Anti-Smoking Measures  
Katsuhide OHASHI .....329

***Brain Death in Children***

- Report on the Criteria for the Determination  
of Brain Death in Children  
Part II: Determination of Brain Death  
in Children in Japan  
Kazuo TAKEUCHI *et al.* .....336

***Topics***

- Clinical Results of Bone Grafting  
Yukihide IWAMOTO .....358

---

**Vol. 45, No. 9**

**September, 2002**

***Bronchial Asthma***

- Inhaled Corticosteroids in the Management  
of Adult Asthma  
Mitsuru ADACHI and  
Toshimichi IMAI .....361

- Self-Management with Peak Expiratory  
Flow Monitoring  
—Treatment for Bronchial Asthma—  
Kazuo AKIYAMA .....369
- How to Use Anti-Allergy Drugs  
Ken OHTA .....375

---

Managing Exacerbation of Asthma: Pharmacologic Therapy	
Koichiro KUDO .....	381
Current Treatment of Childhood Bronchial Asthma Based on the Guidelines	
Toru AKASAKA .....	388

<b>Managed Care</b>	
A Preliminary Study of the Impact of Managed Care on Psychotherapy in Massachusetts	
Hiroto ITO .....	396

<b>Topics</b>	
Treatment of Age-related Macular Degeneration	
Kanjiro MASUDA .....	403

---

**Vol. 45, No. 10**  
**October, 2002**

**JMA Policies**

JMA Professional Medical Liability Insurance Program	
Yuhei MIYASAKA .....	407

**Breast Cancer**

Current Progress in Breast Cancer Treatment: A Consideration of QOL	
Shigemitsu TAKASHIMA .....	416
Chemotherapy and Hormone Therapy for Breast Cancer: Current Status and Perspective	
Yoshinori ITO .....	424

Current Status and Perspectives of Radiation Therapy for Breast Cancer	
Masahiro HIRAOKA <i>et al.</i> .....	434

Post-operative Follow-up of Breast Cancer Patients	
Hideo INAJI <i>et al.</i> .....	440

Is Sentinel Node Biopsy Practical? —Benefits and Limitations—	
Shigeru IMOTO <i>et al.</i> .....	444

**Bioethics**

Frontier Medicine and Ethical Issues	
Fumimaro TAKAKU .....	449

---

**Vol. 45, No. 11**  
**November, 2002**

**JMA Policies**

Outlook for Regional Health Care	
Komei ISHIKAWA .....	453

**Atopic Dermatitis**

Diagnostic Standard for Atopic Dermatitis	
Joji TADA .....	460
Advisory Guidelines for the Avoidance of Exacerbating Factors of Atopic Dermatitis in Daily-Life	
Ichiro KATAYAMA <i>et al.</i> .....	466

Guidelines for Care of Atopic Dermatitis 2001	
Osamu KORO .....	472

Treatment of Atopic Dermatitis with Immunomodulatory Drugs	
Hidemi NAKAGAWA .....	477

Problems Associated with Inadequate Treatment for Atopic Dermatitis	
Kazuhiko TAKEHARA .....	483

Atopic Dermatitis: Psychological Care	
Ryoichi KAMIDE .....	490

---

**Topics**

- Gene Therapy for Peripheral Arterial  
Occlusive Diseases (PAOD)  
Ryuichi MORISHITA and  
Toshio OGIHARA .....496
- 

**Vol. 45, No. 12**

**December, 2002**

***Sexually Transmitted Diseases***

- Recent Trends in *Neisseria gonorrhoeae*  
Infection  
Shoichi ONODERA .....499
- Sexually Transmitted Infections and Sterility  
Masayoshi NOGUCHI and  
Yasuyuki NOGUCHI .....506
- Genital Herpes  
Michihito NIIMURA .....511
- Current Status of *Trichomonas vaginalis*  
Infection, a Sexually Transmitted Disease  
Nobuo KAWAMURA .....516
- Sexual Practices and the Risk for HIV/STDs  
Infection of Youth in Japan  
Masako ONO-KIHARA *et al.* .....520

***Hepatitis C***

- Extrahepatic Manifestation in Hepatitis C  
Hidetsugu SAITO .....526

***Child Development***

- When a Child Shows Signs of Retardation  
in Development  
—When a question arises about  
a child's development—  
Shunsuke NUMAGUCHI .....532

***Psychiatric Disorder***

- Neuroimaging for Diagnosis of  
Psychiatric Disorders  
Yoshio HIRAYASU .....538

- Table of Contents of  
Japan Medical Association Journal  
Vol. 45, Nos. 1–12, 2002 .....545